

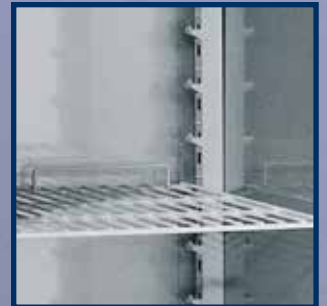

THE QUALITY SOLUTION



ARMADI REFRIGERATI
REFRIGERATED CABINETS
ARMOIRES RÉFRIGÉRÉES
KÜHLSCHRÄNKE

Gli armadi refrigerati secondo Ilsa

Ilsa's concept of the refrigerated cabinets

Les armoires réfrigérées selon ilsa • Kühlschränke nach Ilsa

I Una cucina professionale non ha bisogno soltanto dell'abilità culinaria dei suoi chef. Una cucina professionale necessita di attrezzatura di qualità e apparecchiature funzionali per offrire prodotti eccellenti e un alto livello di servizio. Per questo gli **armadi refrigerati ILSA** non sono solo macchine che vi permettono di conservare al meglio le vostre preparazioni e tutti gli alimenti che utilizzate nel vostro laboratorio, ma sono uno strumento in grado di rendere la vostra cucina un ambiente di lavoro ideale e soprattutto un sistema organizzato ed efficiente. Grazie alle tre linee **Simply**, **Harmony** ed **Elite** avrete la possibilità di scegliere tra numerosi prodotti diversi quello più adatto alle vostre esigenze con la consapevolezza di acquistare sempre e comunque la qualità e l'affidabilità di ILSA.

GB Professional kitchens need much more than skilled chefs. They need top-quality equipment and functional tools that deliver excellent products and top-level service. This is why **ILSA refrigerated cabinets** are not only machines for storing your food and any other product that is used in the kitchen, but also tools that will turn your kitchen into the ideal workplace and above all into a well-organised and efficient work system. You can choose the solution that best suits your requirements from three product lines: **Simply**, **Harmony** and **Elite**, knowing that any product you choose bears witness to ILSA's unmistakable quality and reliability.

F Une cuisine professionnelle ne peut pas se contenter uniquement du savoir-faire culinaire de ses chefs. Une cuisine professionnelle a besoin d'équipements de qualité et d'appareils hautement fonctionnels pour offrir des produits excellents et un niveau de service élevé. C'est pour cela que les **armoires réfrigérées ILSA** ne sont pas seulement des machines qui vous permettront de conserver de la meilleure manière vos préparations et tous les aliments que vous utilisez dans votre laboratoire; les armoires réfrigérées ILSA sont des instruments capables de faire de votre cuisine un espace de travail idéal et, surtout, elles forment un système organisé hautement efficace. Grâce aux trois lignes **Simply**, **Harmony** et **Elite**, vous avez la possibilité de choisir, parmi de nombreux produits différents, celui qui convient le mieux à vos exigences en sachant que, dans tous les cas et toujours, vous achèterez l'incomparable qualité et fiabilité ILSA.

D Eine professionelle Küche basiert nicht nur auf den kulinarischen Fähigkeiten ihrer Chefköche. Eine professionelle Küche erfordert qualitativ hochwertige Küchenausrüstungen und funktionale Küchengeräte, um ausgezeichnete Produkte und ein Top-Serviceniveau zu bieten. Daher sind die **Kühlschränke ILSA** nicht nur Geräte für die optimale Lagerung Ihrer Zubereitungen und aller in der Küche verwendeten Lebensmittel, sondern sind ein Instrument, das in Ihrer Küche eine ideale Arbeitsumgebung schafft und sie vor allem in ein effizient organisiertes System verwandelt. Dank der drei Linien **Simply**, **Harmony** und **Elite** besteht die Möglichkeit, aus zahlreichen verschiedenen Produkten anhand Ihrer spezifischen Anforderungen gezielt auszuwählen, in dem Bewusstsein, sich in jedem Fall für die Qualität und Zuverlässigkeit von ILSA entschieden zu haben.





Simply



I Lo dice la parola stessa: gli armadi refrigerati **Simply** sono facilità d'uso e manutenzione. Grazie alla struttura interna in **ABS** alimentare termoformato che agevola la pulizia e consente maggiore versatilità nell'allestimento. E grazie alle ridotte dimensioni che permettono una facile allocazione della macchina a fronte di una capacità di **500 litri**. Per tutti i professionisti della cucina che cercano una refrigerazione professionale ma semplice e con il minimo ingombro senza rinunciare alle caratteristiche di un prodotto di qualità, come lo spessore di isolamento di 50 mm o il pannello comandi con teletermostato digitale di grande precisione. Inoltre la grande flessibilità di queste macchine permette di scegliere 5 diverse versioni con ranges di temperatura differenziati e di personalizzare l'allestimento a seconda dell'uso con griglie o bacinelle gastronomia, teglie pasticceria e cassette pizza.

GB As the word says, the refrigerated cabinets of the **Simply** line are synonymous with easy use and maintenance. The internal structure is in thermoformed **ABS** suitable for the food industry, which makes cleaning easier and allows for a more versatile customisation of interior fittings. With a capacity of **500 litres**, thanks to their compact shape they can be installed practically anywhere. This equipment is ideal for kitchen professionals who are looking for a refrigeration system that is professional, simple and compact at the same time, without compromising on quality features, incl. 50mm thick insulation and a control panel with a high-precision digital telethermostat. The **Simply** line is also extremely flexible, so you can choose from 5 versions with different temperature ranges and customise the interior fittings to your requirements, choosing from GN racks or containers, pastry trays and pizza trays.



F Son nom le dit parfaitement : les armoires réfrigérées **Simply** sont particulièrement simples à utiliser et à entretenir. La structure interne, en **ABS** thermoformé à usage alimentaire, a été étudiée pour faciliter le nettoyage et permettre une grande flexibilité des équipements internes. Grâce à ses dimensions d'encombrement réduites, et tout en conservant une remarquable capacité de **500 litres**, cette machine trouve très facilement sa place de partout. Cette armoire est idéale pour tous les professionnels de la cuisine qui souhaitent avoir une réfrigération professionnelle et simple, avec un encombrement minimum, mais sans renoncer aux caractéristiques d'un produit de grande qualité avec, par exemple, une épaisseur isolante de 50 mm ou un tableau de commande avec télé-thermostat digital de grande précision. Enfin, la grande flexibilité de ces machines permet de choisir parmi 5 différentes versions, avec des champs de température différenciés, et de personnaliser l'équipement selon l'utilisation souhaité, avec des grilles ou des bacs pour la gastronomie, avec des plateaux pour la pâtisserie et des compartiments type pizza.

D Das Wort selbst sagt es bereits: die Kühlschränke **Simply** sind benutzer- und wartungsfreundlich. Der thermogeformte Innenraum aus lebensmittelverträglichem **ABS** erleichtert die Reinigung und ermöglicht eine vielseitigere Einrichtung. Dank der kompakten Abmessungen findet das Gerät trotz seines Inhalts von **500 l** überall Platz. Für Profiköche auf der Suche nach professioneller und einfacher Kühlung auf kleinstem Raum, ohne auf die Merkmale eines Qualitätsprodukts zu verzichten, wie die 50 mm Isolierung oder die Bedienblende mit hochpräzisem digitalem Fernthermostat. Die große Flexibilität dieser Geräte kommt in 5 verschiedenen Versionen mit differenzierten Temperaturbereichen und der individuellen Einrichtung zum Ausdruck, die je nach Nutzung mit GN-Tragrosten oder GN-Schalen, Konditoreiblechen und Pizzabehältern gestaltet werden kann.





SIMPLY 500



Start



I Gli armadi refrigerati START sono stati progettati per armonizzare sapientemente tecnologia ed efficienza nel rispetto della salute del nostro pianeta: ecco il motivo per cui questi armadi refrigerati sono ECO FRIENDLY: ecologicamente corretti essendo riciclabili al 98,2% (grazie ai materiali innovativi utilizzati per la loro costruzione), poco rumorosi (solo 47 Db), studiati per conservare meglio (significa scarti minori) e per consumare meno energia. Macchine dal design semplice ma raffinato racchiudono specifiche costruttive studiate per semplificare il lavoro dell'utilizzatore sia in gastronomia che in pasticceria. Grazie all'innovativo sistema di controllo elettronico HACCP e all'innovativo sistema monoblocco ad alto rendimento e basso consumo energetico (fino a 45,7% rispetto allo standard medio dei consumi) il freddo, ora, è amico dell'ambiente.

GB The refrigerated cabinet of the START line have been designed to combine technology and efficiency in total respect of the Earth: this is the reason why these cabinets are ECO FRIENDLY: Environmentally friendly because they are recyclable up to 98,2% (thanks to the innovative materials used for their construction), they make less noisy (only 47 Db), specifically design to preserve better (that means less waste) and to save energy. These machine are distinguished themselves by a simple yet refined design and by construction features intended to simplify their use, both in catering and pastry fields. Thanks to the innovative HACCP electronic board and the new high performing monobloc unit now cold is our new green friend.

F Les armoires réfrigérées START ont été conçues pour harmoniser savamment la technologie et l'efficacité dans les secteurs de la gastronomie et pâtisserie en tout respect de notre environnement: elles sont recyclables au 98,2%, elles produisent moins de bruit (seulement 47 Db), elles sont étudiées pour une meilleure conservation (=no gaspillage) et pour consommer moins énergie. Il s'agit des machines au design pur et raffiné, dotées de caractéristiques de fabrication spécialement étudiées afin de simplifier le travail de l'utilisateur. Grâce au système de contrôle électronique la qualité de conservation des produits est toujours garantie et sous contrôle et le système monobloc brevetée à haute rendement permet d'obtenir des économies énergétiques de l'ordre de 45,7% par rapport au standard moyen. Maintenant le froid est ami de l'environnement.

D Die Kühlschränke START wurden entwickelt, um Technologie und Effizienz in der Gastronomie und Konditorei harmonisch zu verbinden. Geräte mit schlichtem und geschmackvollem Design, deren Konstruktionsmerkmale entwickelt wurden um dem Anwender die Arbeit zu erleichtern. Sie sind der Umweltfreundliche Freund, weil Sie weniger Energie verbrauchen, Sie stören weniger (nur 47 Db), Sie sind 98,2% wieder verwendbar, Sie bewahren besser auf (=keine Verschwendungen). Mit der elektronischer Steuerung unterstehen Sie kein Risiko: Die Qualität der Aufbewahrung ist ständig bewacht und gewährleistet. Neue Ilsa Kühlschränke: Unsere jetzige Kühlschränke, sind die Freunde der Umwelt.



PANNELLO COMANDI START



START 700



START 1400



Harmony



I Gli armadi refrigerati **Harmony** sono stati progettati per armonizzare sapientemente tecnologia, efficienza e flessibilità in **gastronomia, pasticceria e gelateria**. Macchine dal design semplice ma raffinato racchiudono specifiche costruttive studiate per semplificare il lavoro dell'utilizzatore:

le celle con gli angoli interni arrotondati per agevolare la pulizia, i robusti piedini regolabili in speciale plastica indeformabile, le griglie GN plastificate con materiale antigraffio, i supporti griglie di nuova concezione stampati in ABS, la centralina comandi digitale di immediata comprensione. Sono solo alcune delle caratteristiche di Harmony. Le altre le lasciamo scoprire a coloro che avranno il piacere di lavorare con i prodotti di questa linea in grado di offrire qualità e prestazioni a tutte le categorie professionali con macchine dedicate, disponibili in numerosi modelli.

GB The refrigerated cabinets of the **Harmony** line have been specifically designed to combine technology, efficiency and flexibility in the **catering, pastry and ice-cream** sectors. These machines are distinguished by a simple yet refined design and have construction features intended to simplify their use: chambers with rounded internal corners for easier cleaning, adjustable feet made of sturdy non-deformable plastic, GN trays coated with scratch-resistant material, rack brackets made of innovative moulded ABS and an easy to use and understand digital control unit. These are only some of the characteristics of the Harmony line. We're leaving the other characteristics to be discovered by those kitchen professionals who will have the pleasure of testing the quality and performance of these machines.

F Les armoires réfrigérées **Harmony** ont été conçues et développées pour harmoniser savamment la technologie, l'efficacité et la flexibilité d'utilisation dans les secteurs de la **gastronomie**, de la **pâtisserie**, des **glaces** et similaires. Il s'agit de machines au design pur et raffiné, dotées de caractéristiques de fabrication spécialement étudiées pour simplifier le travail de l'utilisateur : angles internes des cellules de réfrigération arrondis pour permettre un nettoyage parfait, pieds réglables très solides en matière plastique indéformable, grilles GN plastifiées au moyen d'un matériau anti-rayure, supports de grilles de nouvelle conception, moulés en ABS, une centrale électronique digitale de commandes extrêmement simple à utiliser. Ce ne sont là que quelques-unes des caractéristiques de ces excellents appareils. Les autres nous les laissons découvrir à ceux qui auront le plaisir de travailler avec ces instruments capables d'offrir qualité et performances, avec des machines dédiées à toutes les catégories professionnelles et disponibles en de nombreux modèles.

D Die Kühlschränke **Harmony** wurden entwickelt, um Technologie, Effizienz und Flexibilität in der **Gastronomie, Konditorei** und **Eisdiele** harmonisch zu verbinden. Geräte mit schlichtem und geschmackvollem Design, deren Konstruktionsmerkmale entwickelt wurden, um dem Anwender die Arbeit zu erleichtern: Kühlzellen mit abgerundeten Innenecken für eine einfache Reinigung, robuste Stellfüße aus speziellem formstabilem Kunststoff, kunststoffbeschichtete kratzfeste GN-Tragrostte, neu konzipierte tiefgezogene Tragrosthaltungen aus ABS, digitale sofort verständliche Bedieneinheit. Dies sind nur einige Merkmale dieser Geräte, die Qualität und Leistung bieten und für alle Berufsgruppen in zahlreichen Modellen erhältlich sind. Die übrigen Vorteile können Sie bei der Arbeit mit diesen Geräten selbst entdecken.



HARMONY



HARMONY PASTICCERIA

con regolatore di umidità
with humidity regulator
avec regulateur de humidité
mit Automatische Kondenswasserverdunstung



HARMONY 700



HARMONY 1400



HARMONY 700 + 350 + 350



HARMONY 350 + 350

Elite



I Il concept da cui nascono gli armadi refrigerati Elite si basa sulla volontà di ILSA di offrire il massimo della tecnologia e della qualità agli utilizzatori più esigenti in **gastronomia** e **pasticceria**. La linea comprende tutte le caratteristiche già di alto livello della linea Harmony, alle quali si sommano gli elementi distintivi di Elite. Il

design elegantemente arrotondato, la luce interna e la serratura di serie, la scheda elettronica **INTELLI** con display a cristalli liquidi LCD che permette il monitoraggio dei parametri secondo la normativa **HACCP**. Grazie alla sofisticata tecnologia di questa centralina infatti, oltre alla segnalazione dei guasti o dell'apertura della porta e l'avvio intelligente degli sbrinamenti solo quando necessario, è possibile visualizzare sul display il sistema di allarmi HACCP che garantisce il rispetto delle norme internazionali sulla conservazione degli alimenti.

GB The Elite range of refrigerated cabinets has been inspired by ILSA's desire to offer state-of-the-art technology and top quality to the most demanding clients in the **catering** and **pastry** sectors. The Elite line features the same top qualities of the Harmony line, plus the distinctive features of the Elite line. All cabinets have a delicately rounded design, an internal light and a standard lock. Moreover they are fitted with an **INTELLI** electronic board and an LCD display, where the **HACCP** parameters can be viewed. This innovative electronic control system notifies faults, informs the operator whenever the cabinet door is opened and starts the defrosting cycle only when needed. Furthermore the display shows any alarm referred to the HACCP parameters, which ensures international norms on food storage are complied with.

F Le concept à la base de la conception et réalisation des armoires réfrigérées Elite repose sur la volonté de ILSA d'offrir le maximum de la technologie et de la qualité aux utilisateurs les plus exigeants des secteurs de la **gastronomie** et de la **pâtisserie**. La ligne possède toutes les caractéristiques de haut niveau de la ligne Harmony auxquelles ont été ajoutées les éléments distinctifs de Elite. Le design élégamment arrondi, l'éclairage interne et une serrure de série, une carte électronique **INTELLI** avec afficheur à cristaux liquides LCD qui permet le monitoring des paramètres conformément à la réglementation **HACCP**. En effet, en plus de signaler les éventuelles pannes ou l'ouverture de la porte et le démarrage intelligent des dégivrages uniquement lorsque cela est nécessaire, la haute technologie de cette centrale électronique permet de visualiser le système d'alarme HACCP sur un afficheur afin de garantir le respect des normes internationales relatives à la conservation des aliments.

D Das Konzept der Kühlschränke Elite basiert auf dem Streben von ILSA, den höchsten Benutzeransprüchen in der **Gastronomie** und der **Konditorei** durch modernste Technologie und absolute Qualität gerecht zu werden. Die Linie bietet alle bereits hervorragenden Leistungsmerkmale der Linie Harmony, die durch die Unterscheidungselemente von Elite ergänzt werden. Das elegant abgerundete Design, die Innenbeleuchtung und das serienmäßige Schloss, die Elektronikplatine **INTELLI** mit Flüssigkristalldisplay (LCD) für die Überwachung der Parameter gemäß den **HACCP**-Grundsätzen. Dank der hochmodernen Technologie dieser Bedieneinheit kann am Display neben der Fehleranzeige oder der geöffneten Tür und dem intelligenten Start des Abtaubetriebs nur bei Bedarf, auch das System der HACCP-Alarme angezeigt werden, wodurch die Einhaltung der internationalen Normen für die Lebensmittellagerung gewährleistet ist.



DECREMENTO
Decrease - réduction - senken



INCREMENTO
Increase - augmentation - erhöhen



SET



LUCE
Light - lumière - Licht



SBRINAMENTO
Defrost - dégivrage - Abtauung



ON - OFF



ELITE 700



ELITE 350 + 350



ELITE 1400



ELITE 700 + 350 + 350

HARMONY ed ELITE: il nuovo concept

HARMONY and ELITE: the new concept

HARMONY et ELITE : un nouveau concept

HARMONY und ELITE: Das neue Konzept



I Il costante impegno di ILSA nella ricerca di soluzioni tecnologiche per la refrigerazione ha portato al rinnovamento della gamma armadi refrigerati **Elite** ed **Harmony**.

Grazie alle nuove unità refrigeranti brevettate, sono migliorate le prestazioni garantendo allo stesso tempo minori consumi. Il nuovo basamento delle unità in poliuretano garantisce stabilità dimensionale e migliore isolamento. Il percorso interno dei flussi d'aria è stato completamente rivisto, aumentando l'efficienza e migliorando la conservazione del prodotto. Il nuovo evaporatore, con superficie frontale raddoppiata, consente una maggiore efficacia dello sbrinamento e prestazioni migliori anche con temperature ambiente superiori ai 32°C. L'elevata efficienza abbinata alla gestione "intelligente" dello sbrinamento permette una conservazione del prodotto ottimale.

GB The unabated commitment of ILSA to the search for technological solutions for refrigeration has led to the renewed ranges of refrigerating cabinets **Elite** and **Harmony**.

Thanks to the new patented refrigerating units the performances have improved, thus also guaranteeing reduced energy consumption. The new polyurethane base conveys dimensional stability and better insulation. The inner airflows have been redirected to increase efficiency and improve product preservation. The new evaporator has a doubled front surface to make defrosting more efficient and improve performances also with room temperature over 32°C. The high efficiency combined with the clever defrosting management guarantees the ideal product preservation.

F L'engagement permanent de ILSA dans la recherche de solutions technologiques pour la réfrigération a porté au renouvellement de la gamme des armoires réfrigérées **Elite** et **Harmony**.

Grâce aux nouvelles unités brevetées de réfrigération, les performances ont été améliorées tout en garantissant une réduction de la consommation d'énergie. La nouvelle base des unités garantie leur stabilité dimensionnelle et une meilleure isolation. Le parcours interne des flux d'air a été entièrement revu afin d'augmenter l'efficacité et améliorer la conservation des produits. Le nouvel évaporateur, avec double surface frontale, offre une efficacité accrue du dégivrage et de meilleures performances, y compris avec des températures ambiantes supérieures à 32°C. La remarquable efficacité de l'ensemble, jointe à une gestion "intelligente" du dégivrage, garantit une conservation optimale des produits.

D Das kontinuierliche Engagement von ILSA bei der Suche nach technologischen Lösungen für die Kältetechnik führte zur Erneuerung der Produktreihe der Kühlschränke **Elite** und **Harmony**.

Dank der neuen patentierten Kälteaggregate wurde die Kälteleistung verbessert und der Verbrauch verringert. Der neue Gerätesockel aus Polyurethan sorgt für Dimensionsstabilität und bessere Isolierung. Der innere Luftstrom wurde komplett neu geführt, um die Leistung zu steigern und die Produkte besser zu konservieren. Der neue Verdampfer mit doppelter Frontfläche verbessert die Abtauleistung und die Betriebseigenschaften auch bei Temperaturen von mehr als 32°C. Die verbesserte Leistung durch den "intelligenten" Abtaubetrieb führt zur optimalen Konservierung des Produkts.





IESS e RICS:

IESS and RICS: the innovative systems of Harmony and Elite

IESS et RICS : les systèmes innovateurs d'Harmony et Elite

IESS und RICS: die innovativen Systeme von Harmony und Elite

I Con le sue linee di armadi refrigerati **Harmony** ed **Elite**, ILSA ha voluto offrire il meglio della tecnologia del freddo, progettando sistemi dall'elevato contenuto innovativo che non rispondessero più esclusivamente al bisogno primario di conservare gli alimenti e mantenerne la freschezza nel tempo, ma risolvessero in maniera funzionale problematiche con un'importanza crescente come il risparmio energetico e il monitoraggio dei dati HACCP. Il fatto di aver implementato queste soluzioni in macchine dalle caratteristiche costruttive superiori significa aver messo a disposizione dei propri clienti non delle macchine ma delle vere e proprie soluzioni.

GB With the **Harmony** and **Elite** lines of refrigerated cabinets, ILSA is offering the most advanced refrigeration technology: these highly innovative systems are no longer simply meeting the primary requirements of storing food products and preserving their freshness over time. Indeed, they are also helping kitchen professionals tackle increasingly important problems like energy savings and HACCP monitoring. Having successfully applied these solutions to qualitatively superior machines, ILSA is delivering to its clients actual solutions, rather than simple pieces of equipment.

F Avec ses lignes d'armoires réfrigérées **Harmony** et **Elite**, ILSA a voulu offrir le meilleur de la technologie du froid ; elle a donc étudié et développé des systèmes au contenu hautement innovateur qui, en plus de répondre parfaitement au besoin primaire de conserver les aliments et d'en maintenir la fraîcheur dans le temps, sont capables de résoudre de manière fonctionnelle des problématiques toujours plus importantes, comme les économies d'énergie et le monitoring des données HACCP. Le fait d'avoir implémenté ces solutions dans les machines dotées de caractéristiques de fabrication supérieures signifie mettre à la disposition de nos clients non seulement d'excellentes machines mais de véritables solutions.

D Mit den Produktreihen der Kühlschränke Harmony und Elite bietet ILSA nur das Beste aus der Kältetechnik, durch die Entwicklung von hochinnovativen Systemen, die nicht mehr nur ihren eigentlichen Zweck zur Lagerung und langen Frischhaltung von Lebensmitteln erfüllen, sondern auch auf funktionale Weise Probleme von steigender Bedeutung lösen, wie Energieeinsparung und Überwachung der HACCP-Daten. Da diese Aspekte in Geräte mit überragenden Konstruktionsmerkmalen implementiert wurden, sind sie für die Kunden nicht nur einfache Geräte, sondern wirkliche Lösungen.



Ilsa Energy Saving System (IESS)



I Il sistema **IESS** (ILSA ENERGY SAVING SYSTEM) sfrutta gli innovativi metodi costruttivi degli armadi refrigerati Harmony ed Elite per consentire una drastica riduzione dei consumi energetici e delle spese gestionali dell'impianto. Gli spessori di isolamento di ben **75 mm** (1) per la scocca e di **65 mm** (2) per la porta, le nuove unità refrigeranti monoblocco ad alto rendimento BREVETTATE (3) con tutti i componenti facilmente ispezionabili e il controllo elettronico "intelligente" degli sbrinatori che, grazie al rilevamento automatico della temperatura, attiva lo sbrinatorio solo quando necessario, consentono risparmi energetici fino al 25% rispetto allo standard medio e una manutenzione rapida anche in utenza.

GB The **IESS** system (ILSA ENERGY SAVING SYSTEM) applies the innovative construction features of the Harmony and Elite refrigerated cabinets in order to help clients reduce energy and management costs drastically. The insulation is **75 mm** thick (1) in the structure and **65 mm** thick (2) in the door. The new PATENTED high-performance monobloc refrigeration unit (3) with all the components and the "smart" electronic defrost control system, which measures temperature automatically and activates the defrosting function only when needed, help save up to 25% of energy costs compared to average standards and allow speed maintenance works also by the client.

F Le système d'économie d'énergie **IESS** (ILSA ENERGY SAVING SYSTEM) exploite les méthodes hautement innovatrices de fabrication des armoires réfrigérées Harmony et Elite pour obtenir une réduction drastique des consommations d'énergie et des frais de gestion correspondants. Les épaisseurs d'isolation, de bien **75 mm** (1) pour la coque et de **65 mm** (2) pour la porte, les nouvelles unités de réfrigération monobloc à haut rendement BREVETÉES (3) avec tous les composants faciles à inspecter, et le contrôle électronique "intelligente" des dégivrages qui, grâce à la détection automatique de la température, active le dégivrage uniquement quand cela est nécessaire, permettent de réaliser jusqu'à 25% d'économie d'énergie par rapport au standard moyen d'effectuer une maintenance rapide sur le lieu même d'utilisation.

D Das System **IESS** (ILSA ENERGY SAVING SYSTEM) nutzt die innovative Konstruktionsweise der Kühlschränke Harmony und Elite, um den Energieverbrauch und folglich die Betriebskosten drastisch zu senken. Die **75 mm** Isolierung (1) des Gehäuses und die **65 mm** Isolierung (2) der Tür, die neuen hochleistungsfähigen PATENTIERTE Monoblock-Kältemaschinen (3) und die elektronische "intelligente" Abtaubsteuerung, die dank der automatischen Temperaturmessung den Abtaubetrieb nur bei Bedarf einschaltet, ermöglichen Energieeinsparungen bis zu

25% im Vergleich zum durchschnittlichen Standard. Dies ermöglicht eine schnelle Wartung und eine deutliche Verringerung der Betriebskosten der Anlage.

75 mm

1

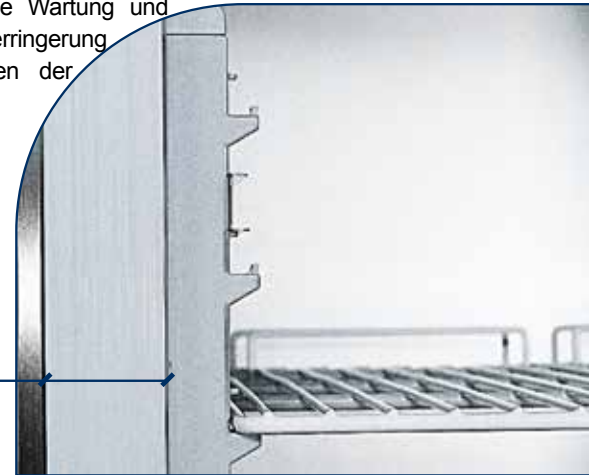

65 mm

2

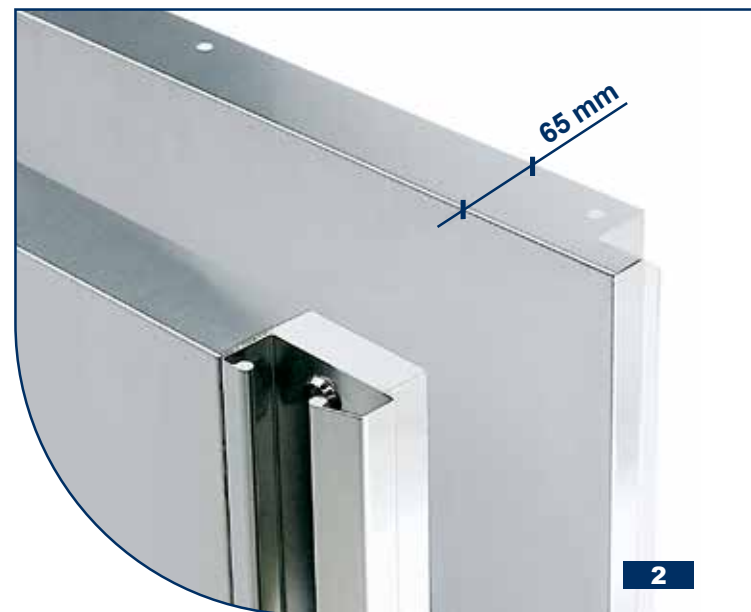

3



Remote Integrated Control System (RICS)











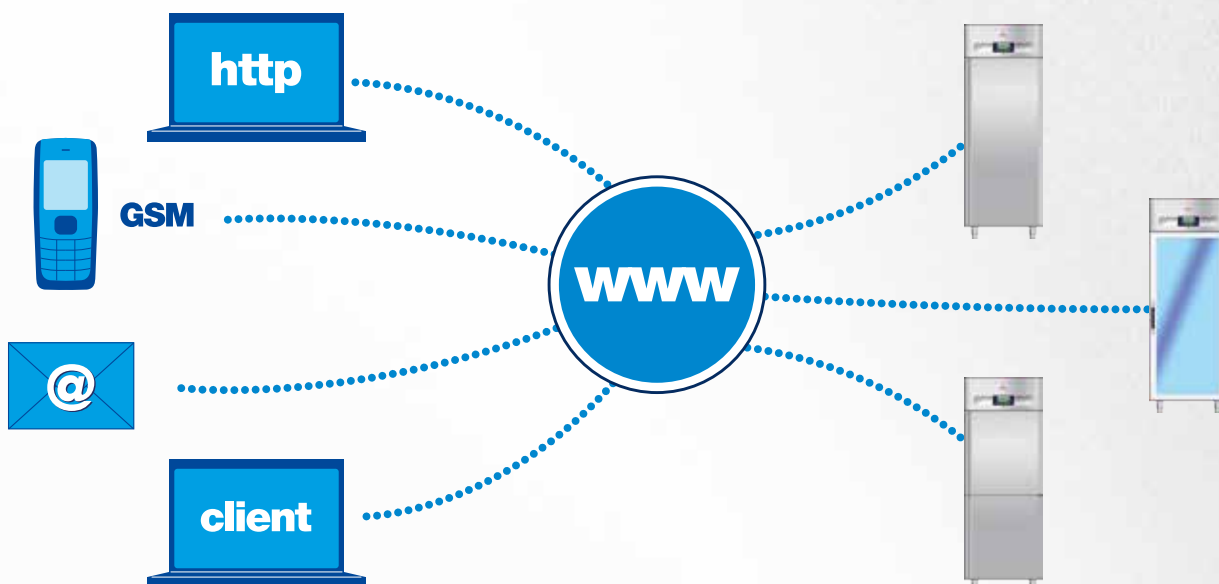



I **RICS** (Remote Integrated Control System) è il sistema per l'acquisizione e il monitoraggio dei dati **HACCP** delle linee ELITE e HARMONY in grado di controllare fino a 100 armadi tramite un pc remoto o una postazione centrale. Questo management software collegando in rete le macchine, consente di visualizzare in qualsiasi momento i dati relativi al loro corretto funzionamento secondo le norme HACCP e rielaborare le informazioni sotto forma di report. RICS inoltre contempla tra le sue funzioni la possibilità di modificare in tempo reale i parametri delle macchine da qualsiasi pc anche esterno all'impianto attraverso un collegamento web. In questo modo l'utente può essere operativo su diversi fronti, il che rappresenta un grosso vantaggio soprattutto se l'ambiente di lavoro è costituito da impianti di grandi dimensioni (industrie alimentari, cantine vinicole, supermercati).

GB The Remote Integrated Control System (**RICS**) acquires and monitors HACCP data from ELITE and HARMONY lines. It can control up to 100 refrigerated cabinets by means of a remote pc or from a central workstation. This management software networks all machines and enables to display at any time the **HACCP** data referred to the cabinets, processing the information and producing reports. RICS can also be used for the real-time editing of parameters from any pc, including external ones, via the Internet. Consequently an individual user can control many different cabinets, which is a great advantage especially if the workplace is rather big (as in the case of food companies, wineries, supermarkets).













F Le **RICS** (Remote Integrated Control System) est un système hautement perfectionné de saisie et de monitoring des données **HACCP** des lignes ELITE et HARMONY ; il est en mesure de contrôler jusqu'à 100 appareils grâce à un ordinateur situé à distance ou au moyen d'une station centrale. Cette gestion par logiciel Software relie les machines en réseau et permet de visualiser à n'importe quel moment les données relatives au parfait fonctionnement des machines, conformément aux normes HACCP, élaborant les informations sous forme de rapports. Le système RICS compte parmi ses fonctions la possibilité de modifier en temps réel les paramètres des machine à partir de n'importe quel ordinateur, y compris à l'installation, au travers d'une simple liaison Internet ; de cette façon, l'utilisateur peut être opérationnel sur différents fronts, ce qui représente pour lui un très gros avantage, en particulier si le milieu de travail est constitué d'installations de grandes dimensions (industries alimentaires, cantines vinicoles, supermarchés).

D **RICS** (Remote Integrated Control System) ist ein System für die Erfassung und Überwachung der **HACCP**-Daten der Kühlschränke ELITE und HARMONY, das bis zu 100 Geräte über einen externen PC oder einen zentralen Arbeitsplatz kontrollieren kann. Mit diesem Softwaremanagement werden die Instrumente vernetzt und können die Daten für einen korrekten Gerätebetrieb gemäß den HACCP-Normen jederzeit visualisiert werden, wobei die Informationen als Report. RICS zählt zu den Funktionen auch die Möglichkeit, die Maschinenparameter von einem beliebigen, auch externen PC, über eine Internetverbindung in Echtzeit zu ändern. Auf diese Weise kann der Benutzer an verschiedenen Fronten tätig sein, was von großem Vorteil ist, vor allem wenn die Arbeitsumgebung aus weit verzweigten Anlagen besteht (Lebensmittelindustrie, Weinkeller, Supermärkte).



	SIMPLY				START							
Modello - Model Modèle - Gerätetyp	500 LT	500 PE	500 PV	500 BT	700 PPS TN	700 PPS BT	1400 PPS TN	1400 PPS BT	PA 60x80 TN	PA 60x80 BT	PA 60x40 TN	
												
T °C	0°C +10°C	-4°C +6°C	+2°C +10°C	-20°C -10°C	-2°C +8°C	-20°C -10°C	-2°C +8°C	-20°C -10°C	-2°C +8°C	-20°C -10°C	-2°C +8°C	
T °C optional												
Funzionamento - Operating mode Fonctionnement - Funktionsweise *	S	S	V	V	V	V	V	V	V	V	V	
Isolamento - Insulation Isolation - Isolierung mm	50	50	50	50	75	75	75	75	75	75	75	
Capacità - Capacity Capacité - Kapazität Lt.	420	420	420	420	600	600	1340	1340	750	750	630	
Dimensioni esterne External Dimension Dimensions externes Außenabmessungen												
Larghezza - Width Largeur - Breite	710	710	710	710	750	750	1500	1500	790	790	790	
Profondità / con porte aperte Depth / with open doors Profondeur / avec portes ouvertes Tiefe / bei offenen Türen	610/ 1285	610/ 1285	610/ 1285	610/ 1285	820/ 1520	820/ 1520	820/ 1520	820/ 1520	1010 / 1750	1010 / 1750	820 / 1580	
Altezza - Height Hauteur - Höhe	1875	1875	1875	1875	2025	2025	2025	2025	2025	2025	2025	
Dimensioni interne Internal Dimension Dimensions intérieures Innen Außenabmessungen												
Larghezza - Width Largeur - Breite	600	600	600	600	600	600	1350	1350	640	640	640	
Profondità - Depth Profondeur - Tiefe	490	490	490	440	670	670	670	670	860	860	670	
Altezza - Height Hauteur - Höhe	1410	1410	1410	1410	1440	1440	1440	1440	1390	1390	1440	
Porte - Doors - Portes - Türen	1, Full	1, Full	1, Glass	1, Full	1, Full	1, Full	2, Full	2, Full	1, Full	1, Full	1, Full	
Refrigerante - Refrigerant type Réfrigérant type - Kältemitteltyp	R404a	R404a	R404a	R404a	R404a	R404a	R404a	R404a	R404a	R404a	R404a	
Quantità di refrigerante Refrigerant quantity Quantité de réfrigérant Kältemittelmenge gr.	180	180	270	350	250	230	280	350	280	320	280	
Potenza assorbita Total Power Puissance Leistung watt	270	270	400	520	280	550	400	770	400	700	400	
Tensione Supply Voltage Tension d'alimentation Anschlussspannung	230 V 50 Hz 1+N	230 V 50 Hz 1+N	230 V 50 Hz 1+N	230 V 50 Hz 1+N	230 V 50 Hz 1+N	230 V 50 Hz 1+N	230 V 50 Hz 1+N	230 V 50 Hz 1+N	230 V 50 Hz 1+N	230 V 50 Hz 1+N	230 V / 50 Hz 1+N	



* S = Statico - Static - Statique - Stille Kühlung / V = Ventilato - Ventilated - Ventile - Umluftkühlung

	START		HARMONY								
Modello - Model Modèle - Gerätetyp	1400 304/ 430 BT	1400 430/ AL BT	700 TN	700 TN	700 BT	700 BT	700 PV TN	700 PV BT	700 PE	350 VTN +350 SBT	
											
T °C	-20°C -10°C	-20°C -10°C	+0°C +10°C	0°C+ +10°C	-20°C -10°C	-20°C -10°C	0°C +10°C	-20°C -10°C	-4°C +6°C	0°C +10°C	-20°C -10°C
T °C optional			-2°C +8°C	-2°C +8°C							
Funzionamento - Operating mode Fonctionnement - Funktionsweise *	V	V	V	V	V	V	V	V	S	V	S
Isolamento - Insulation Isolation - Isolierung mm	75	75	75	75	75	75	75	75	75	75	
Capacità - Capacity Capacité - Kapazität Lt.	1340	1340	600	600	600	600	600	600	600	270	270
Dimensioni esterne External Dimension Dimensions externes Außenabmessungen											
Larghezza - Width Largeur - Breite	1500	1500	750	750	750	750	750	750	750	750	
Profondità / con porte aperte Depth / with open doors Profondeur / avec portes ouvertes Tiefe / bei offenen Türen	820/ 1520	820/ 1520	820/ 1520	820/ 1520	820/ 1520	820/ 1520	820/ 1520	820/ 1520	820/ 1520	820/ 1520	
Altezza - Height Hauteur - Höhe	2025	2025	2025	2025	2025	2025	2025	2025	2025	2025	
Dimensioni interne Internal Dimension Dimensions intérieures Innen Außenabmessungen											
Larghezza - Width Largeur - Breite	1350	1350	600	600	600	600	600	600	600	600	600
Profondità - Depth Profondeur - Tiefe	670	670	670	670	670	670	670	670	670	670	670
Altezza - Height Hauteur - Höhe	1440	1440	1440	1440	1440	1440	1440	1440	1440	645	645
Porte - Doors - Portes - Türen	2, Full	2, Full	1, Full	2x1/2, Full	1, Full	2x1/2, Full	1, Glass	1, Glass	1, Full	2x1/2, Full	
Refrigerante - Refrigerant type Réfrigérant type - Kältemitteltyp	R404a	R404a	R404a	R404a	R404a	R404a	R404a	R404a	R404a	R404a	
Quantità di refrigerante Refrigerant quantity Quantité de réfrigérant Kältemittelmenge gr.	350	350	250 280 (-2 +8°C)	250 280 (-2 +8°C)	230	230	280	350	280	270	230
Potenza assorbita Total Power Puissance Leistung watt	770	770	280 400 (-2 +8°C)	280 400 (-2 +8°C)	550	550	450	600	400	280	320
Tensione Supply Voltage Tension d'alimentation Anschlussspannung	230 V 50 Hz 1+N	230 V 50 Hz 1+N	230 V 50 Hz 1+N	230 V 50 Hz 1+N	230 V 50 Hz 1+N	230 V 50 Hz 1+N	230 V 50 Hz 1+N	230 V 50 Hz 1+N	230 V 50 Hz 1+N	230 V 50 Hz 1+N	

* S = Statico - Static - Statique - Stille Kühlung / V = Ventilato - Ventilated - Ventile - Umluftkühlung















HARMONY







350 VTN +350 STN		1400 TN	1400 TN	1400 TN	1400 BT	1400 BT	1400 BT	1400 PVTN	1400 PVBT	700 TN + 700 BT		700 BT + 700 BT		700 TN+700 TN		
0°C +10°C	0°C +10°C	0°C +10°C	0°C +10°C	0°C +10°C	-20°C -10°C	-20°C -10°C	-20°C -10°C	0°C +10°C	-20°C -10°C	0°C +10°C	-20°C -10°C	-20°C -10°C	-20°C -10°C	0°C +10°C	0°C +10°C	
		-2°C +8°C	-2°C +8°C	-2°C +8°C				-2°C +8°C								
V	S	V	V	V	V	V	V	V	V	V	V	V	V	V	V	
75		75	75	75	75	75	75	75	75	75	75	75	75	75	75	
270	270	1340	1340	1340	1340	1340	1340	1340	1340	600	600	600	600	600	600	
750		1500	1500	1500	1500	1500	1500	1500	1500	1500	1500		1500		1500	
820/ 1520		820/ 1520	820/ 1520	820/ 1520	820/ 1520	820/ 1520	820/1520	820/1520	820/1520	820/1520		820/1520		820/1520		
2025		2025	2025	2025	2025	2025	2025	2025	2025	2025	2025		2025		2025	
600	600	1350	1350	1350	1350	1350	1350	1350	1350	600	600	600	600	600	600	
670	670	670	670	670	670	670	670	670	670	670	670	670	670	670	670	
645	645	1440	1440	1440	1440	1440	1400	1400	1440	1440	1440	1440	1440	1440	1440	
2x1/2, Full		2, Full	1+2x1/2, Full	4x1/2, Full	2, Full	1+2x1/2, Full	4x1/2, Full	2, Glass	2, Glass	2, Full		2, Full		2, Full		
R404a		R404a	R404a	R404a	R404a	R404a	R404a	R404a	R404a	R404a		R404a		R404a		
270	230	320	280 320 (-2 +8°C)	280 320 (-2 +8°C)	350	350	350	400	500	250	230	230	230	250	250	
280	250	430	400 430 (-2 +8°C)	400 430 (-2 +8°C)	770	770	770	500	950	280	550	550	550	280	280	
230 V 50 Hz 1+N		230 V 50 Hz 1+N	230 V 50 Hz 1+N	230 V 50 Hz 1+N	230 V 50 Hz 1+N	230 V 50 Hz 1+N	230 V 50 Hz 1+N	230 V / 50 Hz 1+N	230 V / 50 Hz 1+N	230 V / 50 Hz 1+N		230 V / 50 Hz 1+N		230 V / 50 Hz 1+N		

	HARMONY											
Modello - Model Modèle - Gerätetyp	700 STN + 700 TN		1050 TN + 350 BT		1050 TN + 350 TN		PA 60X80 TN	PA 60X80 BT	PA 60X40 TN	PA 60X40 BT	700 GE	700 GE
												
T °C	0°C +10°C	0°C +10°C	0°C +10°C	-20°C -10°C	0°C +10°C	0°C +10°C	-2°C +8°C	-20°C -10°C	-2°C +8°C	-20°C -10°C	-25°C -15°C	-25°C -15°C
T °C optional												
Funzionamento - Operating mode Fonctionnement - Funktionsweise *	S	V	V	V	V	V	V	V	V	V	V	V
Isolamento - Insulation Isolation - Isolierung mm	75	75	75	75	75	75	75	75	75	75	75	75
Capacità - Capacity Capacité - Kapazität Lt.	600	600	930	270	930	270	750	750	630	630	680	680
Dimensioni esterne External Dimension Dimensions externes Außenabmessungen												
Larghezza - Width Largeur - Breite	1500		1500		1500		790	790	790	790	750	750
Profondità / con porte aperte Depth / with open doors Profondeur / avec portes ouvertes Tiefe / bei offenen Türen	820/1520		820/1520		820/1520		1010/ 1750	1010/ 1750	820/ 1580	820/ 1580	930/ 1630	930/ 1630
Altezza - Height Hauteur - Höhe	2025		2025		2025		2025	2025	2025	2025	2025	2025
Dimensioni interne Internal Dimension Dimensions intérieurs Innen Außenabmessungen												
Larghezza - Width Largeur - Breite	600	600	600	600	600	600	640	640	640	640	600	600
Profondità - Depth Profondeur - Tiefe	670	670	670	670	670	670	860	860	670	670	780	780
Altezza - Height Hauteur - Höhe	1440	1440	1440	645	1440	645	1390	1390	1440	1440	1440	1440
Porte - Doors - Portes - Türen	2, Full		1+2x1/2, Full		1+2x1/2, Full		1, Full	1, Full	1, Full	1, Full	1, Full	2x1/2, Full
Refrigerante - Refrigerant type Réfrigérant type - Kältemitteltyp	R404a	R404a	R404a	R404a	R404a	R404a	R404a	R404a	R404a	R404a	R404a	R404a
Quantità di refrigerante Refrigerant quantity Quantité de réfrigérant Kältemittelmenge gr.	280	250	280	230	280	250	280	320	280	350	320	320
Potenza assorbita Total Power Puissance Leistung watt	400	280	400	550	400	280	400	700	400	550	700	700
Tensione Supply Voltage Tension d'alimentation Anschlussspannung	230 V / 50 Hz 1+N		230 V / 50 Hz 1+N		230 V / 50 Hz 1+N		230 V 50 Hz 1+N	230 V 50 Hz 1+N	230 V 50 Hz 1+N	230 V 50 Hz 1+N	230 V 50 Hz 1+N	230 V 50 Hz 1+N

* S = Statico - Static - Statique - Stille Kühlung / V = Ventilato - Ventilated - Ventile - Umluftkühlung

ELITE

700 TN	700 TN	700 BT	700 BT	700 PV TN	700 PV BT	1400 TN	1400 TN	1400 TN	1400 BT	1400 BT	1400 BT	1400 PVTN	1400 PVB T
													
-2°C +8°C	-2°C +8°C	-25°C -15°C	-25°C -15°C	0°C +10°C	-20°C -10°C	-2°C +8°C	-2°C +8°C	-2°C +8°C	-25°C -15°C	-25°C -15°C	-25°C -15°C	0°C +10°C	-20°C -10°C
V	V	V	V	V	V	V	V	V	V	V	V	V	V
75	75	75	75	75	75	75	75	75	75	75	75	75	75
600	600	600	600	600	600	1340	1340	1340	1340	1340	1340	1340	1340
750	750	750	750	750	750	1500	1500	1500	1500	1500	1500	1500	1500
820/ 1530	820/ 1530	820/ 1530	820/ 1530	820/ 1530	820/ 1530	820/ 1530	820/ 1530	820/ 1530	820/ 1530	820/ 1530	820/ 1530	820/ 1530	820/ 1530
2025	2025	2025	2025	2025	2025	2025	2025	2025	2025	2025	2025	2025	2025
600	600	600	600	600	600	1350	1350	1350	1350	1350	1350	1350	1350
670	670	670	670	670	670	670	670	670	670	670	670	670	670
1440	1440	1440	1440	1440	1440	1440	1440	1440	1440	1440	1440	1440	1440
1, Full	2x1/2, Full	1, Full	2x1/2, Full	1,Glass	1,Glass	2, Full	1+2X1/2, Full	4X1/2, Full	2, Full	1+2X1/2, Full	4X1/2, Full	2, Glass	2, Glass
R404a	R404a	R404a	R404a	R404a	R404a	R404a	R404a	R404a	R404a	R404a	R404a	R404a	R404a
280	280	350	350	280	350	370	370	370	500	500	500	400	620
400	400	550	550	450	600	430	430	430	850	850	850	500	1050
230 V 50 Hz 1+N	230 V 50 Hz 1+N	230 V 50 Hz 1+N	230 V 50 Hz 1+N	230 V 50 Hz 1+N	230 V 50 Hz 1+N	230 V 50 Hz 1+N	230 V 50 Hz 1+N	230 V 50 Hz 1+N	230 V 50 Hz 1+N	230 V 50 Hz 1+N	230 V 50 Hz 1+N	230 V 50 Hz 1+N	230 V 50 Hz 1+N

	ELITE										
Modello - Model Modèle - Gerätetyp	700 PE	350 VTN +350 SBT		350 VTN +350 STN		350 VTN +350 SPE		700 TN +700 BT		700 BT +700 BT	
											
T °C	-4°C +6°C	-2°C +8°C	-25°C -15°C	-2°C +8°C	-2°C +8°C	-2°C +8°C	-4°C +6°C	-2°C +8°C	-25°C -15°C	-25°C -15°C	-25°C -15°C
T °C optional											
Funzionamento - Operating mode Fonctionnement - unktionsweise *	S	V	S	V	S	V	S	V	V	V	V
Isolamento - Insulation Isolation - Isolierung mm	75	75	75	75	75	75	75	75	75	75	75
Capacità - Capacity Capacité - Kapazität Lt.	600	270	270	270	270	270	270	600	600	600	600
Dimensioni esterne External Dimension Dimensions externes Außenabmessungen											
Larghezza - Width Largeur - Breite	750	750		750		750		1500		1500	
Profondità / con porte aperte Depth / with open doors Profondeur / avec portes ou- vertes Tiefe / bei offenen Türen	820/ 1530	820/1530		820/1530		820/1530		820/1530		820/1530	
Altezza - Height Hauteur - Höhe	2025	2025		2025		2025		2025		2025	
Dimensioni interne Internal Dimension Dimensions intérieurs Innen Außenabmessungen											
Larghezza - Width Largeur - Breite	600	600	600	600	600	600	600	600	600	600	600
Profondità - Depth Profondeur - Tiefe	670	670	670	670	670	670	670	670	670	670	670
Altezza - Height Hauteur - Höhe	1440	645	645	645	645	645	645	1440	1440	1440	1440
Porte - Doors - Portes - Türen	1, Full	2x1/2, Full		2x1/2, Full		2x1/2, Full		2, Full		2, Full	
Refrigerante - Refrigerant type Réfrigérant type - Kältemit- teltyp	R404a	R404a	R404a	R404a	R404a	R404a	R404a	R404a	R404a	R404a	R404a
Quantità di refrigerante Refrigerant quantity Quantité de réfrigérant Kältemittelmenge gr.	280	270	230	270	230	270	230	280	350	350	350
Potenza assorbita Total Power Puissance Leistung watt	400	280	320	280	250	280	250	400	550	550	550
Tensione Supply Voltage Tension d'alimentation Anschussspannung	230 V 50 Hz 1+N	230 V / 50 Hz 1+N		230 V / 50 Hz 1+N		230 V / 50 Hz 1+N		230 V / 50 Hz 1+N		230 V / 50 Hz 1+N	

* S = Statico - Static - Statique - Stille Kühlung / V = Ventilato - Ventilated - Ventile - Umluftkühlung

ELITE

700 TN +700 TN		700 STN +700 TN		1050 TN +350 BT		1050 TN +350 TN		PA 60X80 TN	PA 60X80 BT	PRA 60X80 TN
										NEW
-2°C +8°C	-2°C +8°C	-2°C +8°C	-2°C +8°C	-2°C +8°C	-25°C -15°C	-2°C +8°C	-2°C +8°C	-2°C +8°C	-20°C -10°C	+4°C +18°C
V	V	S	V	V	V	V	V	V	V	V
75	75	75	75	75	75	75	75	75	75	75
600	600	600	600	930	270	930	270	750	750	750
1500		1500		1500		1500		790	790	790
820/1530		820/1530		820/1530		820/1530		1010/ 1750	1010/ 1750	1010/ 1750
2025		2025		2025		2025		2025	2025	2025
600	600	600	600	600	600	600	600	640	640	640
670	670	670	670	670	670	670	670	860	860	860
1440	1440	1440	1440	1440	645	1440	645	1390	1390	1390
2, Full		2, Full		1+2x1/2, Full		1+2x1/2, Full		1, Full	1, Full	1, Full
R404a	R404a	R404a	R404a	R404a	R404a	R404a	R404a	R404a	R404a	R404a
280	280	280	280	280	230	280	250	280	320	280
400	400	400	400	400	550	400	280	400	700	400
230 V / 50 Hz 1+N		230 V / 50 Hz 1+N		230 V / 50 Hz 1+N		230 V / 50 Hz 1+N		230 V 50 Hz 1+N	230 V 50 Hz 1+N	230 V 50 Hz 1+N



UNI ENI ISO 9001:2008

ILSA spa
Via Ferrovia 31 - San Fior (TV) - Italy
Tel. +39.0438.4905 r.a. - Fax +39.0438.405491
www.ilsaspa.com - ilsa@ilsaspa.com