



HERSTELLER VON MULTIFUNKTIONALEN TECHNOLOGIEN

GEGRÜNDET 1992

JUMP zu Kochen, Grillen, Frittieren
schneller als klassische Technik
unter digitaler Überwachung
24 Stunden verfügbar



AGENDA



WER WIR SIND
GERÄTE JIPA JUMP
REFERENZEN
TECHNISCHE INFORMATIONEN

UNSERE PHILOSOPHIE

Verkauf über
Vertragshändler

Verkauf auf Basis eines
Reservierungssystems

Individuelle
Partnerbetreuung

Familiengeführtes
Unternehmen

Tschechisches
(Europäische) Produkt



EXPORT REGIONS

Europe

Czech Republic, Slovakia

Germany, Austria

Switzerland,

Benelux, Spain

England, Ireland

Poland, Baltic

Scandinavia,

Australia

NME

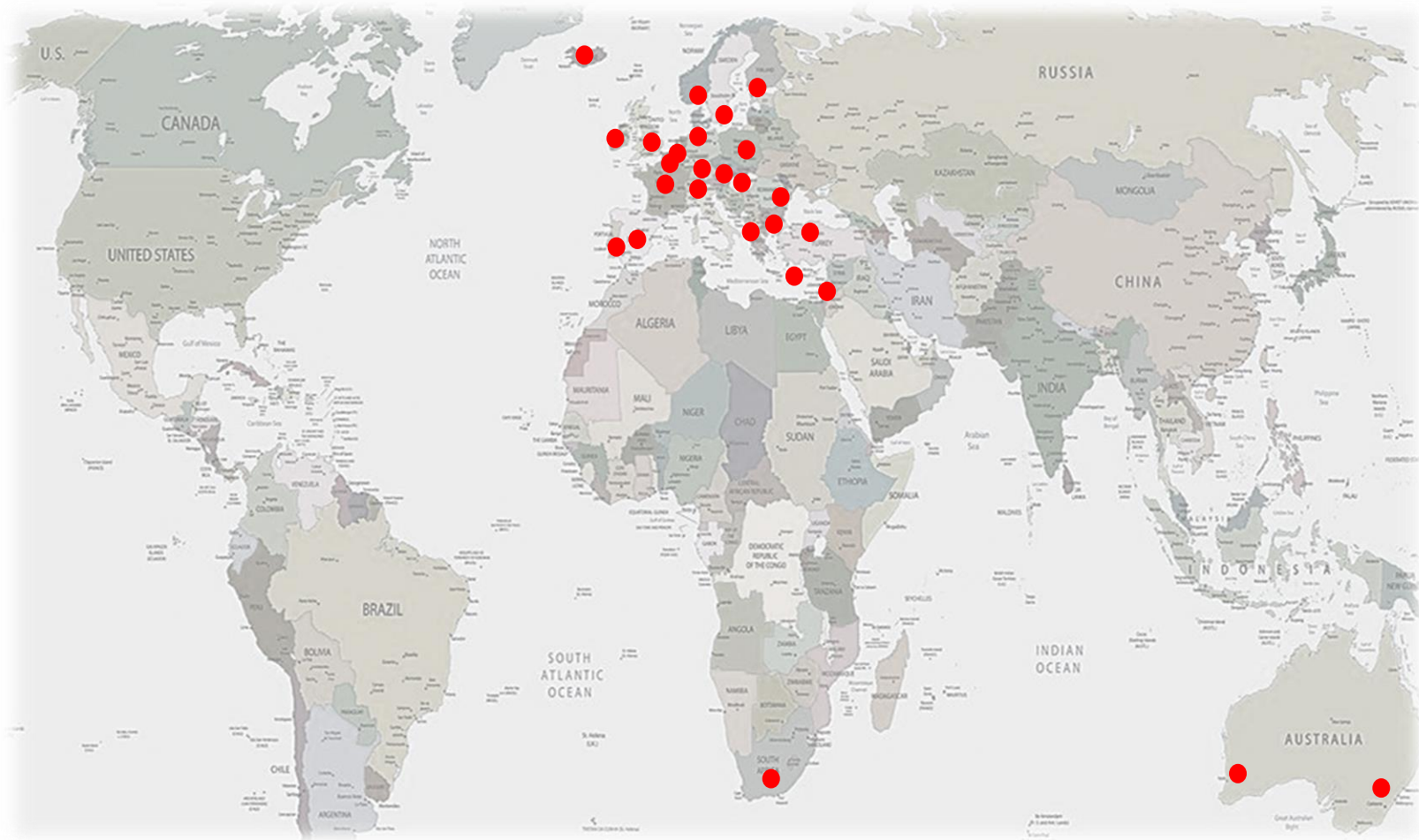

EINZIGARTIGE TECHNOLOGIE

Konstruktion – Schwerlast-
Gastronomiegeräte

Power - einzigartiges
Heizsystem JPX

Funktionalität –
serienmäßig - automatisches
Anheben des Korbes,
Ablassen, elektronischer
Kippen und Deckel

Projektoptionen - Ansatz für
jeden Kunden mit Größe oder
potenziellen Optionen



iipa[®]
INTERNATIONAL

PRODUKTION

Cca. 85% Primärproduktion
in der werk

Professionelle Ausrüstung

Fachkräfte

Lasergeräte und Roboter

Nahezu alle Teile der
Primärproduktion

Qualitätskontrolle an einem
Ort

iipa[®]
INTERNATIONAL

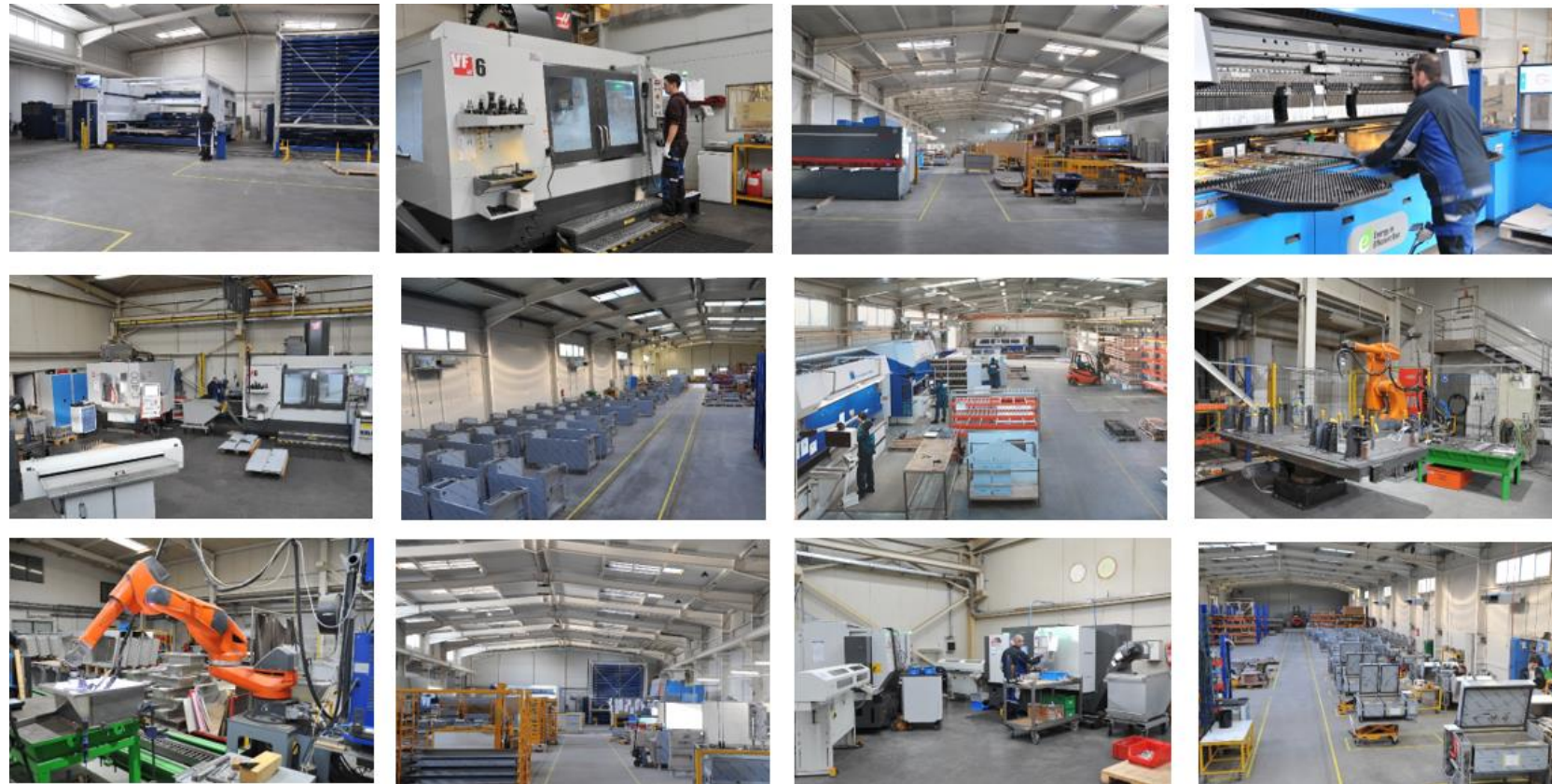

PRODUKTIONSGESCHICHTE

30 Jahre Geschichte

Know-How

Langjährige Erfahrung mit
rostfreiem Stahl

Bekannte Unternehmen in
der Region CZ, DE, A, CH

iipa[®]
INTERNATIONAL



AGENDA



GERÄTE JIPA JUMP

MODELLE LINIE

JIPA JUMP

JUMP 101DS - 2x30 Liter

JUMP 101DM - 2x50 Liter

JUMP 101DL - 2x80 Liter

JUMP 101 - 100 Liter

JUMP 151 - 150 Liter

JUMP 201 - 200 Liter



MODIFIKATION DER MODELLE

FLACHE VERSION

TIEF 22 cm

JUMP 101F 75 Liter

JUMP 151F 110 Liter

JUMP 200F 150 Liter

TIEFE VERSION

JUMP 251 250 Liter

DRUCKGERÄT

0,48 bar

JUMP 101P 100l Liter

JUMP 151P 150l Liter

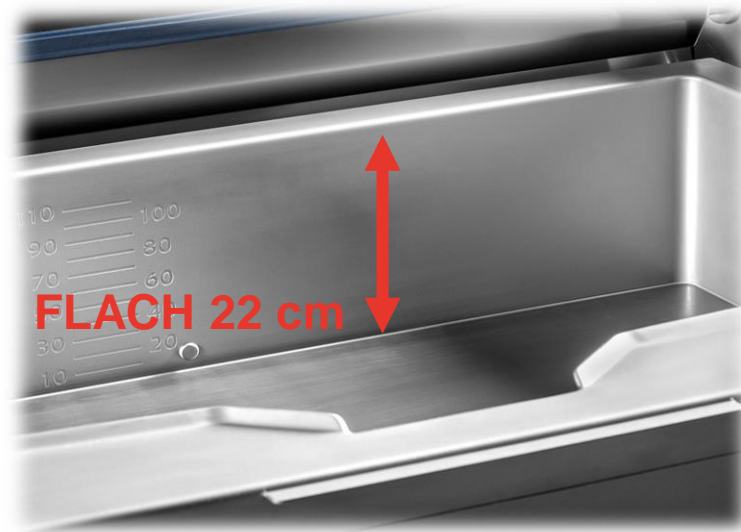

iipa[®]
INTERNATIONAL



**MODIFIKATION DER
MODELLE**

FLACHE VERSION

TIEF 22 cm

/Standard tief 28cm/

JUMP 101F 75 Liter

JUMP 151F 110 Liter

JUMP 200F 150 Liter



ipd[®]
INTERNATIONAL

**REDUZIERT TIEF
AUF 22 CM**

ERGONOMETRISCH

KALTE ECKEN

MODIFIKATION DER MODELLE

DRUCKGERÄT

0,48 bar

JUMP 101P 100 Liter

JUMP 151P 150 Liter

iipa[®]
INTERNATIONAL



iipd DESIGN

**Farbiges 12“ Touchscreen
Display + Programmierung**

**Stromsteckdose und USB
Buchse am Bein**

**Spezial -Tiegelboden mit
beiderseitiger Verschweißung**

**Hygienische Aufnahme für
Kerntemperaturfühler**

**Ablassen des überflüssigen
Dampfs mittels Öffnung in
Deckelmitte**

Füllstandsanzeige

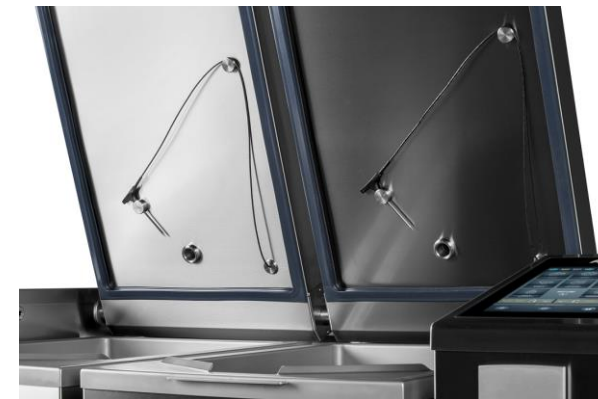

iipd[®]
INTERNATIONAL

iipd STANDARD

Automatischer Hub der Körbe

Mehrpunkt-
Kerntemperaturfühler

Integrierte Brause mit
Aufrollautomatik

JPX 17 – Flächenheizung mit
dickschicht Heizkörpern

Isolierter Tiegel sorgt für
minimalen Stromverbrauch

Automatischer System für
Wasser Befüllung

Elektronischer
Sicherheitsablauf

Internetanschluss + HACCP

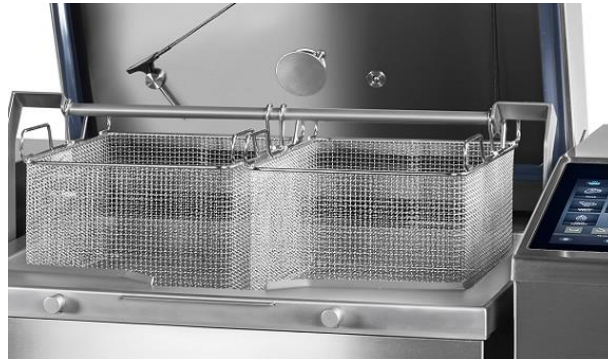

iipd[®]
INTERNATIONAL

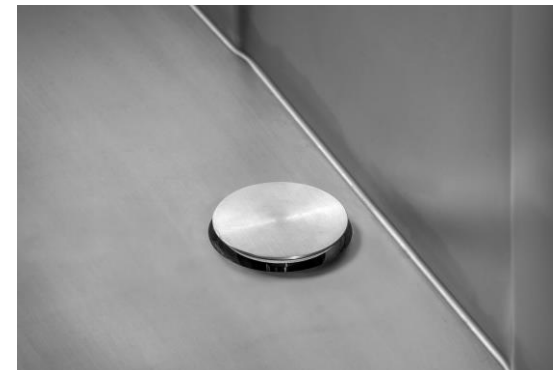
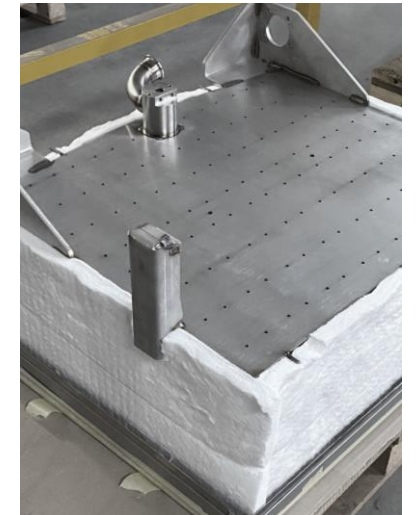
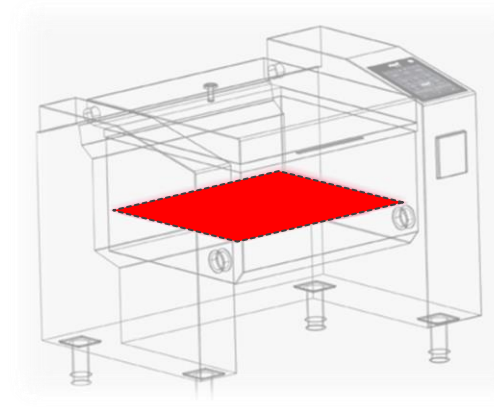

SCHNELLES VORHEIZEN
JIPA JUMP

JPX 17 – Flächenheizung

**Vorheizen des Bodens
auf 180°C in 3 Minuten**

Wasser Kochen in 12 min

Isolierter Tiegel – ECO

**Tiegel – Material CNS (DIN
1.4401), beiderseits
verschweißt**

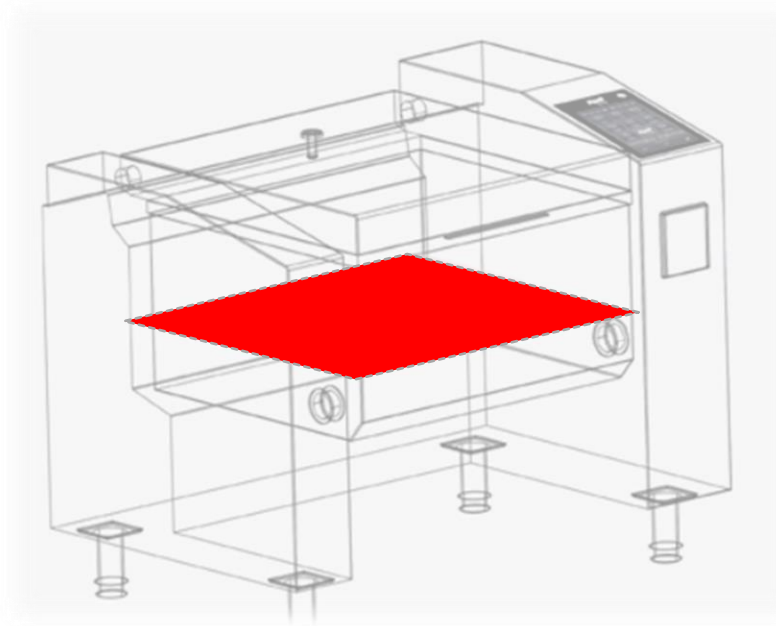

jipa[®]
INTERNATIONAL

JPX 17 – Flächenheizung →



Spezial -Tiegelboden

**WAEMEHALTUNG DER
TEMPERATUR
JIPA JUMP**

**Isolierter Tiegel sorgt für
minimalen Stromverbrauch**

Halten der Temperatur

Material Tiegel DIN 1.4436



jipa[®]
INTERNATIONAL

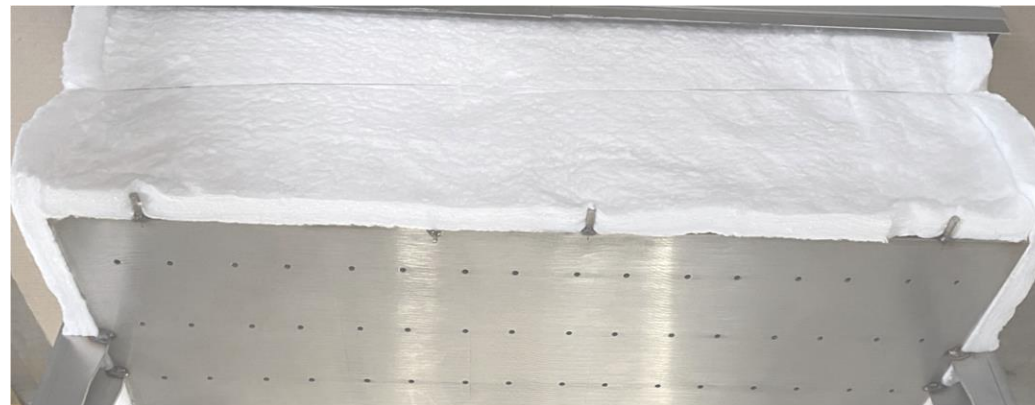
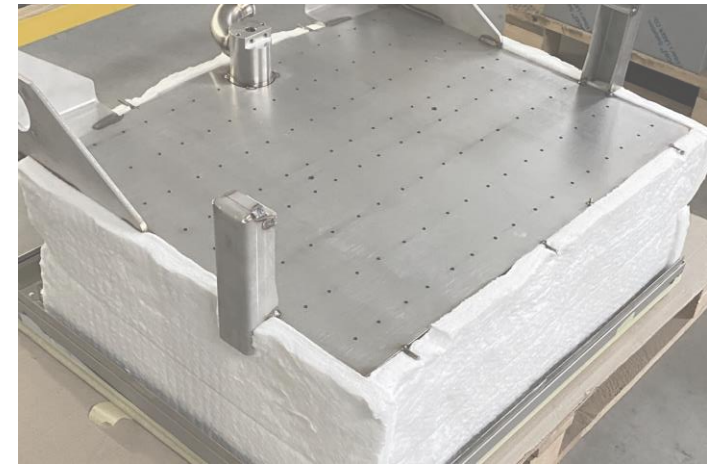

ZUBEHÖR-WAGEN

**LEKTRO – BATTERIE –
HEBEWAGEN**– Mobile
Benutzung ohne festem
Stromanschluss

ÖLFILTERWAGEN– Sichere
Ölfilterung und lagerung

**TRANSPORTGESTELLWAG
EN FÜR FRITTIER – UND
KOCHKÖRBE –**

Einfaches und sicheres
Aufbewahren, Transportieren
und Abtropfen der Behälter



ipd[®]
INTERNATIONAL

ZUBEHÖR

Garkorb

Frittierkorb

Spachtel

Arm für automatisches

Heben der Körbe

Putzschwamm

Rost 1/1 für NT – Garen

Abseihsieb

Kleine Körbe für

À-la-carte-Gerichte

Spätzlesieb

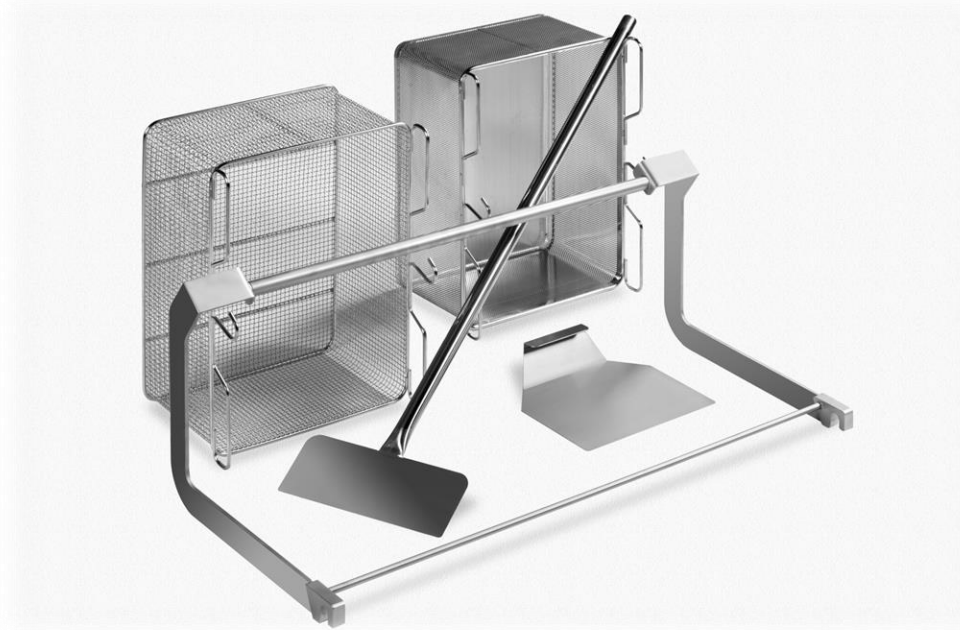

iipä[®]
INTERNATIONAL



KLASSISCHE KÜCHE

7 Stücke Koch Kessel

2 Stücke Kippffanne

2 Stücke Fritteuse

6 Heizplätze

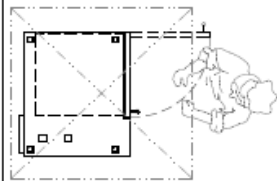

KÜCHE 800 pax

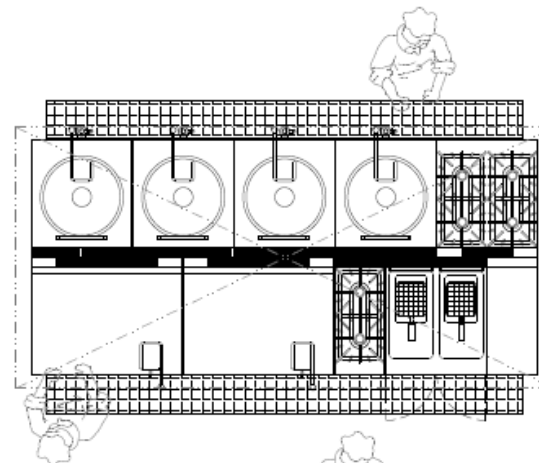
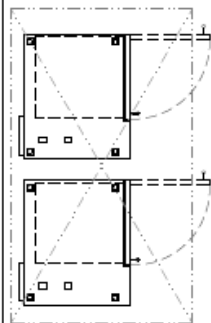

VARNA

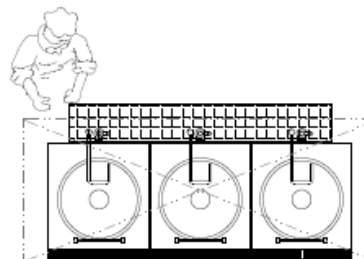

VÝDEJ JÍDEL

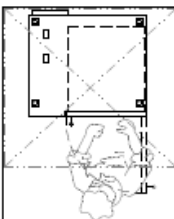

iipd[®]
INTERNATIONAL

MULTI-
FUNKTIONALE KÜCHE

JIPA JUMP

Flexibel und platzsparend

1 x 101DS (2 x 29L)

1 x 101DM (2 x 49L)

1 x 151F (110L)

1 x 201 (201L)

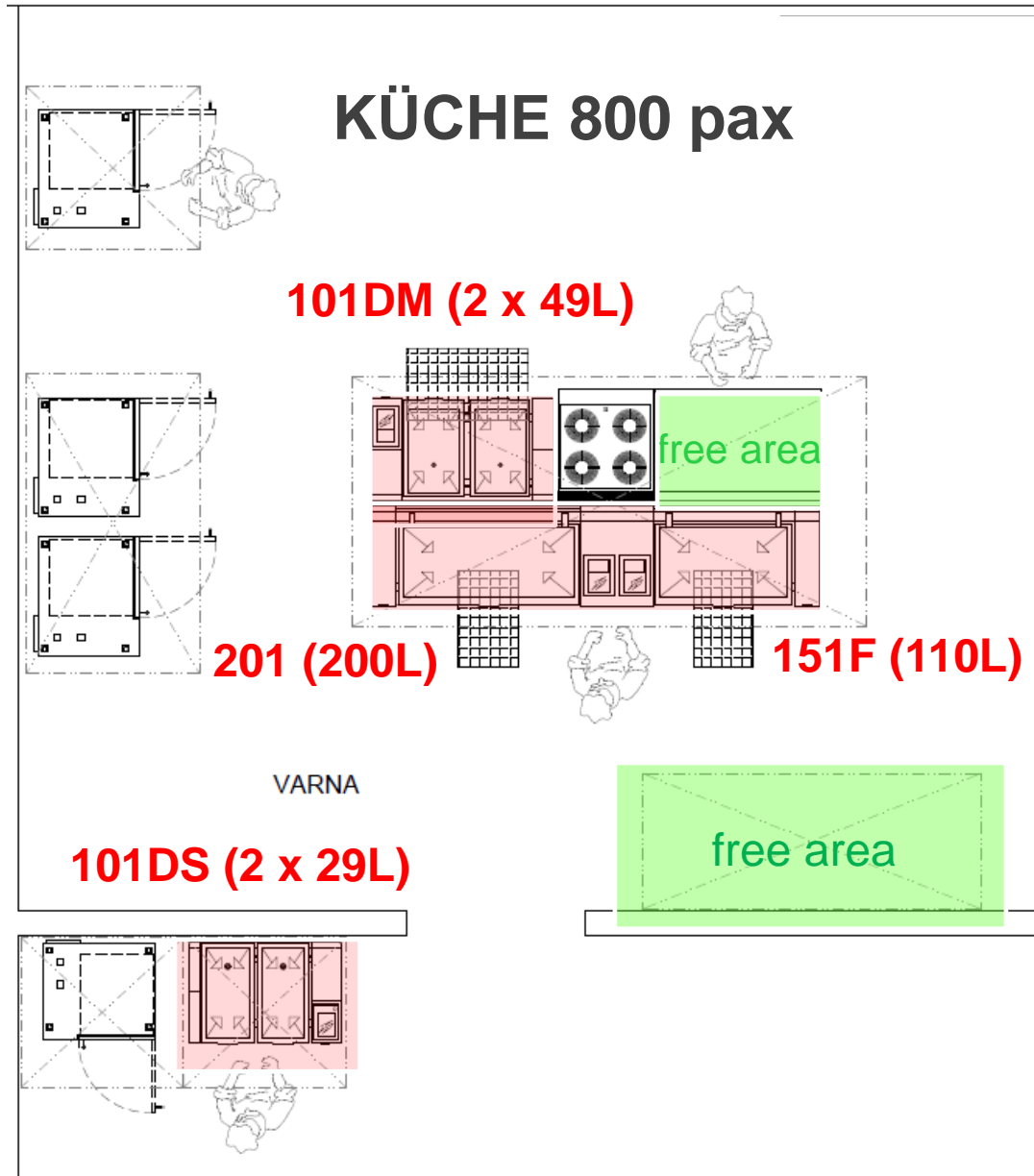

AGENDA

REFERENZEN

JIPA JUMP 101 DS

2x30 liters



jipa[®]
INTERNATIONAL



JIPA JUMP 101 DM
2x50 liters



jipa[®]
INTERNATIONAL

JIPA JUMP 101 DL

2x80 liters



jipa[®]
INTERNATIONAL

JIPA JUMP 101

100 liters



jipa[®]
INTERNATIONAL

JIPA JUMP 151

150 liters

jipa[®]
INTERNATIONAL



JIPA JUMP 201

200 liters



jipa[®]
INTERNATIONAL

JIPA JUMP 251

250 liters



jipa[®]
INTERNATIONAL

JIPA JUMP 101P
100 liters

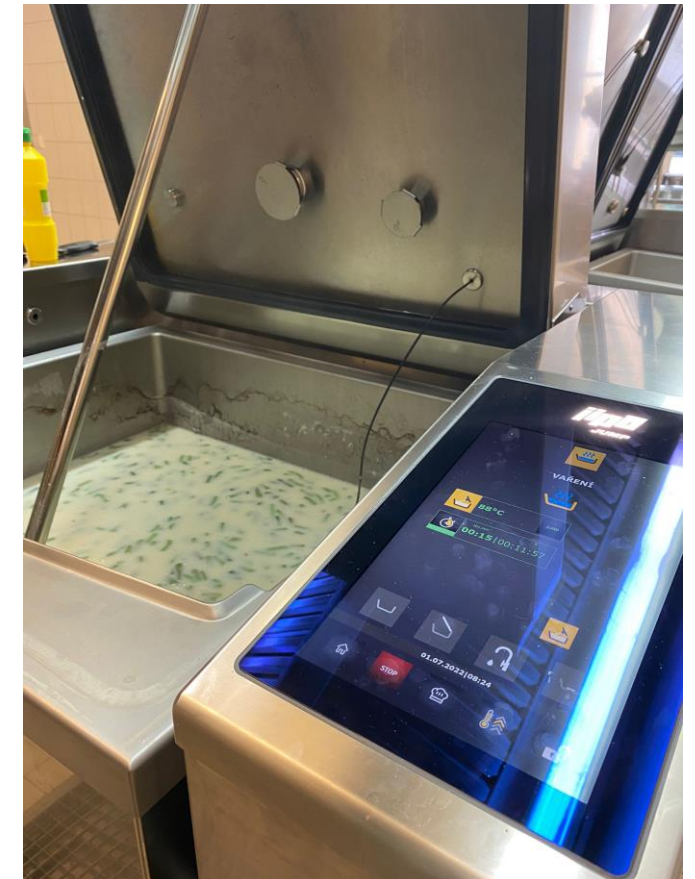

jipa[®]
INTERNATIONAL

JIPA JUMP 151P

150 liters



jipa[®]
INTERNATIONAL

JIPA JUMP 101DM

jipa[®]
INTERNATIONAL



JIPA JUMP 101DS

iipa[®]
INTERNATIONAL



JIPA JUMP 200F + 151P



JIPA JUMP - 2 DIFFERENT INSTALLATIONS 101DM BE

jipa[®]
INTERNATIONAL



JIPA JUMP - 2 DIFFERENT INSTALLATIONS 101DM BE

jipa[®]
INTERNATIONAL



07.07.2023

JIPA JUMP 101DM + 101

jipa[®]
INTERNATIONAL



JIPA JUMP 101DS

jipa[®]
INTERNATIONAL



JIPA JUMP 151

iipa[®]
INTERNATIONAL

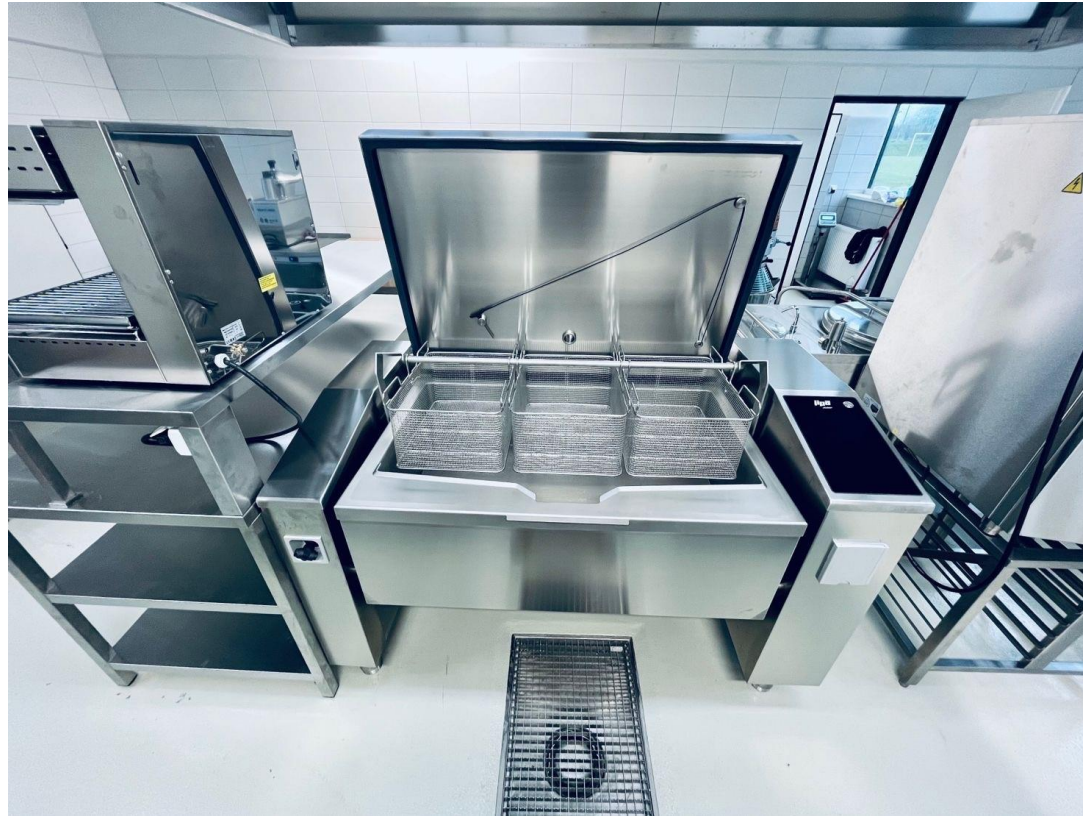

JIPA JUMP 101DM

<https://navystavisti.cz/areal/bohemia/>

jipa[®]
INTERNATIONAL



JIPA JUMP 251 + OLD 2X 201

<https://www.fnbrno.cz/en/the-university-hospital-brno/t1000>



JIPA JUMP 101DM+101P

<https://annabels.co.uk/>



jipa[®]
INTERNATIONAL



JIPA JUMP 101DM

jipa[®]
INTERNATIONAL



JIPA JUMP 201+151P+151

<https://www.youtube.com/watch?v=14z-tzqKA5U>

jipa[®]
INTERNATIONAL



JIPA JUMP 101P

<https://www.volareza.cz/vll-frantiskovy-lazne/>

jipa[®]
INTERNATIONAL



JIPA JUMP 151 + 151

jipa[®]
INTERNATIONAL



JIPA JUMP 101

iipa[®]
INTERNATIONAL



JIPA JUMP 151



JIPA JUMP 3 x 101

jipa[®]
INTERNATIONAL



JIPA JUMP 101

<https://www.vikenco.no/about-1#about-2>

jipa[®]
INTERNATIONAL



07.07.2023

JIPA JUMP 101, 101DM, 151, 251

jipa[®]
INTERNATIONAL



JIPA JUMP 101DS

jipa[®]
INTERNATIONAL

<https://www.bidfood.cz/gastrostudio>



JIPA JUMP 151P + 151P

jipa[®]
INTERNATIONAL



07.07.2023

JIPA JUMP 101DS + 101DM

jipa[®]
INTERNATIONAL



07.07.2023

JIPA JUMP 101



www.the-connaught.co.uk

JIPA JUMP 151

jipa[®]
INTERNATIONAL



JIPA JUMP 101DM

jipa[®]
INTERNATIONAL



JIPA JUMP 151



JIPA JUMP 101DM ENODIS FRANCE CEPROC CENTRE D'EXCELLENCE DES PROFESSIONS CULINAIRES

<https://www.ceproc.com/>

jipa[®]
INTERNATIONAL



JIPA JUMP 101DM

jipa[®]
INTERNATIONAL



JIPA JUMP 101DM + 201

jipa[®]
INTERNATIONAL



JIPA JUMP 101DM

jipa[®]
INTERNATIONAL



JIPA JUMP 101DM

jipa[®]
INTERNATIONAL



JIPA JUMP 101DS

<https://roycehotel.com.au/>

jipa[®]
INTERNATIONAL



JIPA JUMP 151P + 201

jipa[®]
INTERNATIONAL



JIPA JUMP 101, 101DS HOTEL VAN DER VALK 5* AMSTERDAM HOLLAND



<https://www.vandervalkamsterdam.com/en>



JIPA JUMP 101DM HOTEL DES MAURES ENODIS FRANCE

<https://hotellerie-des-maures.fr/>

ipd[®]
INTERNATIONAL



JIPA JUMP 101DM ENODIS FRANCE SRESTAURANT-CUEILLETTE.FR

<https://restaurant-cueillette.fr/>

jipa[®]
INTERNATIONAL



07.07.2023

JIPA JUMP 101DS RESTAURANT-TWENTYNINE SWITZERLAND



https://www.rational-online.com/en_in/references/restaurant/de-twentynine-glattbrugg.php

JIPA JUMP 101D QSR TO GO TONKANTERS HOLLAND



<https://tonkanters.nl/>



JIPA JUMP 101D KUNSTHALLE PRAHA

<https://www.kunsthallepraha.org/>

iipa[®]
INTERNATIONAL



JIPA JUMP 151 SCHOOL HOROMĚŘICE

jipa[®]
INTERNATIONAL



JIPA JUMP 2 X 101 + 3 X 151 CVUT PRAHA NEW INSTALATION 2016



JIPA JUMP 2 X 101 + 3 X 151 CVUT PRAHA AFTER 6 YERS

jipa[®]
INTERNATIONAL



07.07.2023

JIPA JUMP 151 SCHOOL PRAHA 4

jipa[®]
INTERNATIONAL



JIPA JUMP 251 UPTOWN-SQ LIMASSOL, CYPRUS

jipa[®]
INTERNATIONAL



AGENDA

TECHNISCHE INFORMATIONEN

Installation Informationen

JIPA JUMP

Abfluss DN 50

Wasseranschluss 1/2"

Elektroanschluss

Anschluss RJ 45

Potentialausgleich

JIPA JUMP 101 DS – 2x30 liters

- Gesamtanschlusswert – 22,5 kW
- Sicherung – 3x32 A

JIPA JUMP 101DM – 2x50 liters

- Gesamtanschlusswert – 27,5 kW
- Sicherung – 3x40 A

JIPA JUMP 101DL – 2x80 liters

- Gesamtanschlusswert – 36,9 kW
- Sicherung – 3x50 A

JIPA JUMP 101 – 100 liters

- Gesamtanschlusswert – 24,6 kW
- Sicherung – 3x32 A

JIPA JUMP 151 – 150 liters

- Gesamtanschlusswert – 36,9 kW
- Sicherung – 3x50 A

JIPA JUMP 201 – 200 liters

- Gesamtanschlusswert – 49,2 kW
- Sicherung – 3x63 A

JIPA JUMP 251 – 251 liters

- Gesamtanschlusswert – 49,2 kW
- Sicherung – 3x63 A



DATENBLATT

JIPA JUMP 101

JIPA JUMP

Alle Informationen in
unserem Datenblatt

Technische Daten

Technologie + Funktionen

Konstruktion + Standard

Zeichnung

Zubehör

iipa[®]
INTERNATIONAL

iipa[®]
INTERNATIONAL

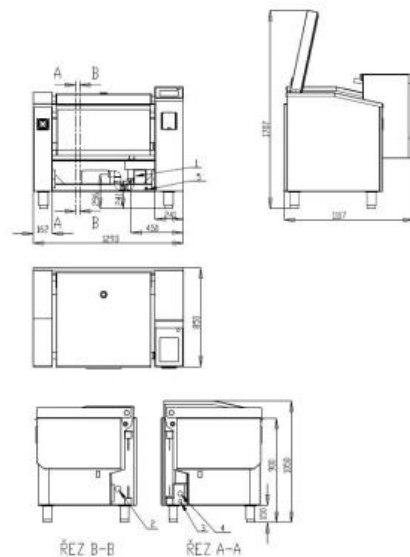

- ① Drain DN 50
- ② Water connection
- ③ Electro connection
- ④ Ethernet socket RJ 45
- ⑤ Ground

JIPA International s.r.o.
Formancká 6, 149 00 Praha-Újezd u Příhořic | Czech Republic | www.iipainternational.cz

iipa[®]
INTERNATIONAL

Recommended accessories:

- Spatula big
- Spatula for omelettes
- Basket extension arm
- Cooking and frying baskets
- Sieve
- Spaetzle sieve



- Oil filtration trolley



- Battery – powered lifting trolley



- Grate for NT 1/1



JIPA International s.r.o.
Formancká 6, 149 00 Praha-Újezd u Příhořic | Czech Republic | www.iipainternational.cz

Sicherheit geht vor mit
JIPA JUMP

Die Wasserversorgung ist
vom elektrischen Teil der
Maschine getrennt

Linkes Bein – Wasser

Rechtes Bein – Strom

Umdrehen möglich

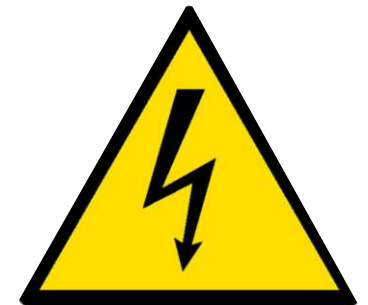

jipa[®]
INTERNATIONAL

Installation

Wand oder vom Boden

JIPA JUMP

Dank des Lochs auf der
Rückseite der Maschine

können Sie

Wasserverdunstung sowohl
vom Boden als auch von
der Wand möglich

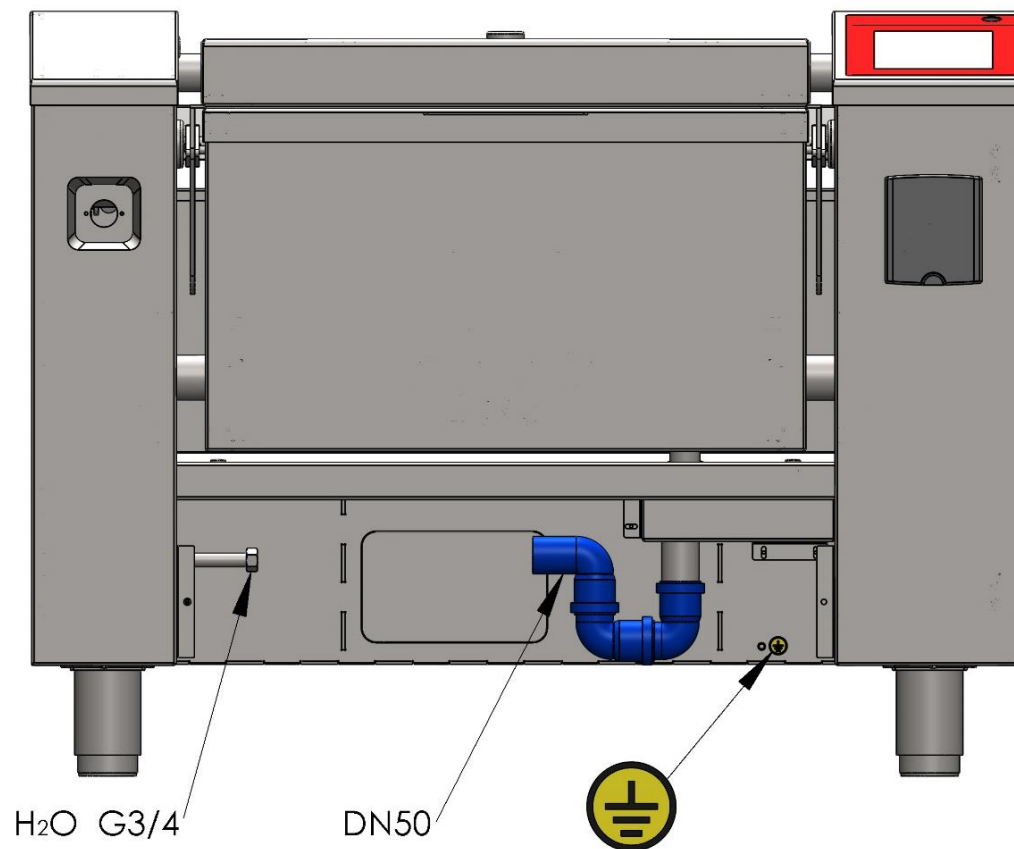

Internetverbindung **JIPA ROUTE**

Einfacher Zugang zum
Gerät über das Internet

Die Kontakt Informationen
müssen an unseren
Kollegen gesendet werden

Dies ist die Option für
Köche und Service



iipa ROUTE®

Firs what we need before opening account „JIPA ROUTE“

Username:	
Password:	
Name and surname:	
Company:	
Telephone:	
E-mail:	
Country:	
City:	
Street:	

And send to: bosak@jipainternational.cz

After just go to

https://jiparoute.tecomat.com/TR_LOGIN.XML

- 1) Here you enter Username and password and Login.
Zde napišete Username a heslo a dáte Login

Internetverbindung **JIPA ROUTE**

- HACCP download
- Service-Informationen
- Dienstzugriff und Fehleridentifizierung
- Programme übertragen
- Software-Aktualisierung

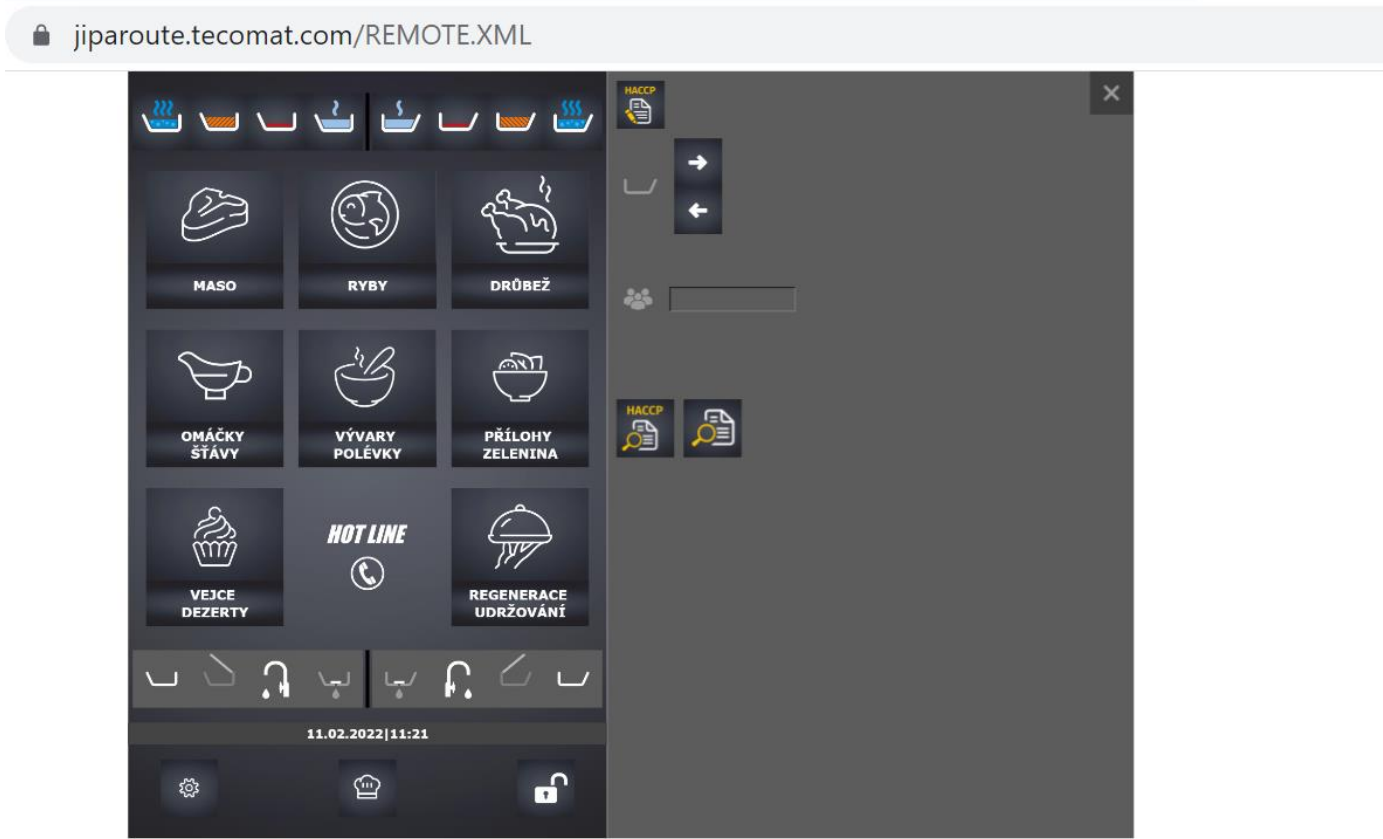

Internetverbindung JIPA ROUTE

HACCP Informationen
Service Informationen
Service zugriff und
Fehleridentifizierung

t.com/R_VIEW.XML

datum	cas	teplota L	jehla/cas L	teplota P	jehla/cas P
220209-09:49:14			Viko otevřeno P		
220209-09:49:16			Viko otevřeno P		
220209-09:50:00				765M,6	
220209-09:51:00				7545,5	
220209-09:52:00				7542,2	
220209-09:53:00				7540,7	
220209-09:54:00				7439,3	
220209-09:55:00				7435,3	
220209-09:56:00				7439,6	
220209-09:57:00				7437,4	
220209-09:58:00				7436,7	
220209-09:59:00				7435,9	
220209-10:00:00				7435,4	
220209-10:01:00				7335,0	
220209-10:02:00				7334,8	
220209-10:03:00				7334,5	
220209-10:04:00				7334,1	
220209-10:05:00				7334,2	
220209-10:05:25			Konec vaření P		
			Program P Firemní varetka		
			MASO VAŘENÍ NDC ČERVENÁ MASA		
			spotřeba za vaření P:2.815 [kWh]		
			Vypnut režim udržování teploty HOLD P		
	2022,0			7334,2	
220209-10:45:52			Napouštění vody P začátek		
220209-10:46:07			Napouštění vody L konec:0,53 l		
220209-10:46:37			Start vaření P		
			Program manuální		
			Režim - vaření P		
				teplota P 99°C	
220209-10:46:37			Viko otevřeno P		
	2022,1			3427,2	
220209-10:46:42			Napouštění vody P začátek		
220209-10:46:58			Napouštění vody L konec:0,85 l		
220209-10:47:00				3126,8	
220209-10:47:15			Konec vaření P		
			Program manuální		
			spotřeba za vaření P:0.119 [kWh]		
	2022,0			2726,3	
220209-10:50:38			Režim - vaření L		
			Program manuální		
			Režim - vaření L		
				teplota L 99°C	
220209-10:50:46			Viko otevřeno L		
	2022,0			1928,6	
220209-10:50:46			Viko otevřeno L		
			Program manuální		
			spotřeba za vaření L:0.072 [kWh]		
				1623,6	
220210-10:47:23			Zapnutí zařízení		
10.02.22 13:24:16			### Zapnutí zařízení		
11.02.22 11:12:33			### Zapnutí zařízení		

_VIEW.XML

datum	cas	SET/RES	Index	Error/Warning
10.02.22	13:24:13	SET	131	P
		SET	132	P
		SET	133	W
		SET	134	W
		SET	135	W
		SET	136	W
		SET	137	W
13:24:14		RES	132	P
		RES	133	W
		RES	134	W
		RES	136	W
		RES	137	W
13:24:15		RES	132	P
		RES	133	W
		RES	134	W
		RES	136	W
		RES	137	W
13:24:15		RES	133	W
		RES	136	W
		RES	134	W
13:24:15		RES	137	W
13:24:15		RES	135	W
		RES	138	W
13:24:15		RES	133	W
13:24:15		RES	136	W
13:24:15		RES	134	W
13:24:15		RES	137	W
13:24:15		RES	135	W
13:24:15		RES	138	W
13:24:15		RES	133	W
13:24:16		RES	134	W

USB
Anschlussmöglichkeiten
JIPA JUMP

HACCP herunterladen
Programme übertragen
Service-Informationen
Software-Aktualisierung
WI-FI Verbindung ist
möglich



JIPA WEB

JIPA YOU TUBE

All data available on
online platforms

<https://en.jipainternational.cz/>

<https://www.youtube.com/channel/UCfhn4ufcSyX7rzGoIC-vHOQ>



The image shows a composite of two screenshots. The top screenshot is the JIPA International website header, featuring the logo, contact information (info@jipainternational.cz), social media icons, and a navigation menu with items like 'Úvod', 'Produkty', 'Příslušenství', 'O nás', 'Download', 'Kontakt', and 'Kde působíme'. The bottom screenshot is a YouTube channel page for 'JIPA International', showing the channel name, subscriber count (77), and a video player with a list of recent uploads including 'Jipa Jump CZ' and 'PŘEHRÁT VŠE'.



THANK YOU

